

New Super-Het Questions and Answers; Low Loss Variable Condenser Facts; Crystal Set Panel Layout; Two Variometer Hook-Up; Week's Program News

# Radio Digest

EVERY WEEK **Illustrated** PROGRAMS **TEN CENTS**

REG. U. S. PAT. OFF. & DOM. OF CANADA

Vol. XI

Copyright 1924  
By Radio Digest Publishing Co.

SATURDAY, DECEMBER 6, 1924

No. 9

## LISTEN IN ON ELECTRONS



Left, Harriet Murton, coloratura soprano who, during the California Industries Exposition at the Civic Auditorium, sang a number of songs from Station KPO. Below, Vivien Potter, the beautiful announcer of Station KPOX, at Seattle, Washington. This is a new 1,000-watt station. At the right of her, Vronne Farr, soprano, recently heard singing from Station WIP by thousands of fans.

### ATOMIC NOISE HEARD TOO BY RESEARCHERS

*Is New Step in Science*

General Electric Laboratory Men and University of Michigan Professor Demonstrate Feat

SCHENECTADY, N. Y.—Hearing broadcasting stations thousands of miles away may be thrilling, but it hasn't half the thrill nor the importance of the recent accomplishment of hearing electrons, the basic particles of matter (so far as we now know) from which everything, including the human body, is made.

Scientists of the General Electric company and the University of Michigan have succeeded in listening in to the electron.

The vacuum tube amplifier, amplifying sounds 100,000 times and 1,000,000 times if need be, has made this possible.

The sound of the electrons is caused when they leave the hot filament and bombard the plate of a regular, Radio vacuum tube. It is these electrons which carry the current charges and make possible the operation of the tube.

These facts were brought out in a paper read by Dr. A. W. Hull of the research laboratory of the General Electric company, at a meeting of the American Physical society, describing experiments

### THOUSANDS ATTEND THIRD ANNUAL SHOW

CHICAGO GREETES VISITORS  
AT YEARLY DISPLAY

Attendance So Large Many Turned  
Away from Doors—Exhibitors  
Agree on Success.

CHICAGO.—Taken from every point of view, the third annual Radio show held in this city, was a huge success. Thousands of people being turned away from the doors nightly, because of the large attendance.

More than \$6,000 worth of apparatus, donated by exhibitors for the benefit of  
(Continued on page 2)

### FIVE SUPER POWER LICENSES GRANTED

WASHINGTON.—Four more class B stations, which have applied to increase power to 1,500 watts, have been licensed temporarily under the regulations providing that no additional interference is caused. Increased power has been authorized for KYW, Westinghouse, Chicago; WBZ, Westinghouse, Springfield, Mass.; KFI, Earl C. Anthony, Los Angeles; and WEAF, A. T. & T., New York. The first station licensed was WTAM, at Cleveland.



conducted by Dr. N. H. Williams of the University of Michigan and himself, in which they listened to electrons.

Atoms, the next largest particles of matter and constituted of electrons, but  
(Continued on page 2)

### HOW TO BUILD A SET GIVEN BY JOE COOK

NEW YORK.—All folks not knowing how to build a Radio set received the most specific and technical treatise ever attempted by any mortal, when Joe Cook, famous actor, related his story recently from Station WHN in this city. Everyone who was sufficiently heavily insured, and didn't care how hearty they laughed, tuned in to hear the description. It was told as only Joe Cook can tell it.

### LISTEN TO ELECTRONS

(Continued from page 1)

still far too small to be seen by the world's most powerful microscope, have also been heard just recently by General Electric company scientists.

The roar of iron atoms as they are attracted by a magnet is plainly heard by the use of a special device used in connection again with a vacuum tube amplifier and a Radio loud speaker.

The special device carries out the idea of a German scientist, Dr. H. Barkhausen of Dresden. A piece of soft iron is inserted in a coil of 17,000 turns of wire which is connected to the amplifying system.

As the soft iron atoms twist about to agree with the polarity of a magnet brought close, the roaring sound is produced in the loud speaker or head phones attached to the amplifying system.

#### Noise Parallels Number of Electrons

Returning to the research on the sound of electrons, carried on by Dr. Hull and Dr. Williams, it is interesting to know that the noise is proportional to the number of electrons which fly across from filament to plate each second.

The purpose of the electron sound investigation was to determine in a new way the quantity of electricity carried by an electron. This has been done previously by Professor of Physics Millikan of the University of Chicago using what is known as the oil-drop method.

By the procedure used by Doctors Hull and Williams it is possible to obtain values of high accuracy, thus getting an independent check on Millikan's determination. The measurements thus far made by this method give a value for the charge of the electrons within one-half of one per cent of that obtained by Millikan. Though as yet less accurate than the results of the experiments of Millikan, these measurements are capable of refinement which may equal or exceed in accuracy the oil-drop method.

#### Electron's Debut Only Recent

Not long ago the electron was unknown. First scientists had the molecule, itself so small that man has not yet seen it. Then came the atom, the minute integral part of the molecule. For a long time the atom was considered as the smallest particle of matter.

But each element presents a different atom. Science was not content to rest. It sought to connect all phenomena, and the electron was the result.

Scientists now believe that all matter is composed of electrons and that different substances result from the different properties possessed by the atoms according to the number and arrangement of the electrons they contain.

### CHICAGO SHOW CLOSSES

(Continued from page 1)

the Radio fund for the blind, was auctioned off to the public on the closing night. William Hale Thompson, former mayor of Chicago, started the auction, knocking down a R. C. A. super-heterodyne receiver for \$150.

#### Attendance Greatest Ever

One of the touching donations to the fund was that of \$27.50 by employees of the Coliseum. During the week more than \$600 was collected at various booths and through the crowd by flower girls selling roses.

The total attendance for the week was 139,902, against 125,000 at the New York show.

Each night various broadcasting stations rendered part of their program from the studio in the Coliseum. A special program was broadcast on 80 meters by Station 9XBG, owned by E. T. Flewelling, prominent Radio engineer. An orchestra composed entirely of blind musicians gave their services. This was the first time that a blind orchestra has played for a station broadcasting on such a low wave length.

#### Exhibitors Pleased with Show

Eastern manufacturers who came to Chicago to exhibit this year for the first time, expressed their surprise and widespread interest at the scale of the show, admitting it to be far greater than the one held in New York.

On Wednesday, November 19, the attendance was the greatest that had ever been present at a Radio show. Managers of the exposition stating that 28,399 were listed as paying admission on that day.

The show closed with the singing of "The Star Spangled Banner" by Miss Edith Bennett, followed by "Auld Lang Syne."

### WHERE WEIRD TALES ARE TOLD



A camp fire scene in the Adirondack mountains—old pals—and the Radio set. Modern jazz mixed into hunting tales amid the charm of the camp fire. A sheet of tin makes a very good loud speaker horn in the open spaces.

#### Receivers for Blind

NEW YORK.—The American Radio association, headquarters here, has started a campaign to raise funds to equip with Radio all homes where blind persons dwell. To this end contributions toward the fund are asked through local newspapers or directly to the American Foundation for the Blind, 41 Union Square, New York city. Old sets, and spare parts are not desired, as it is believed best to purchase new equipment, which will be done with the approval of an advisory committee on

which government Radio experts will be represented.

#### Radio "Eiffel Tower" for Berlin

LONDON.—A Radio message just received from Berlin says that work has started in that city on the construction of an "Eiffel Tower" for Radio transmission work. The tower will be over 430 feet high. It will contain a restaurant 155 feet above the ground, while 15 feet from the top there will be an observation platform accessible by an elevator.

## CONTENTS

Radio Digest, Illustrated, Volume XI, Number 9, published Chicago, Illinois, December 6, 1924. Published weekly by Radio Digest Publishing Company, 510 N. Dearborn Street, Chicago, Illinois. Subscription rates, yearly, Five Dollars; Foreign Postage One Dollar additional; single copies Ten Cents. Entered as second-class matter at the postoffice at Chicago, Illinois, under the Act of March 3, 1879.

All the Live News of Radio.....	1 to 8
Keep Growing Wiser—Order of Hoot Owls.....	5
An Eight Dollar Crystal Set with Selectivity, Part II—Panel Layout and List of Parts .....	9
An Evening at Home with the Listener In, a chart showing when to listen in for your favorite station.....	10
Advance Programs for the Week at the Larger Stations.....	11 to 14
"Low Loss," What It Is and Why, by Jacques Fournier.....	15
Editorial; Indi-Gest; Condensed by Dielectric.....	16
How to Build the Simplest Possible Super-Het, Part IV—Answers to Some Questions Asked, by John G. Ryan.....	17
Helpful Hints to Get the Most from Radio, Chapter XII—Telephones and Loud Speakers, by Thomas W. Benson.....	19
Selective Hook-Up for Long Distance, by Winston Kock.....	21
Questions and Answers.....	22
Radiophone Broadcasting Stations, Part III.....	23

### Looking Ahead

**Experimenters—Plenty of Food for Experiment** will be given you beginning next issue, when Prof. J. E. Owen, chief of the bureau of standards at the University of Oklahoma, begins his series of articles telling you how to use the odds and ends about the house to demonstrate to your own satisfaction what really makes the Radio "go." Don't miss the start of this!

**Jacques Fournier's Interesting Treatise on "Low Loss"** will be continued next issue, taking more variable condensers into consideration. He will criticize the Hammarlund, Continental, Garod, Premier and Lincoln makes. Watch for the description of the low loss set soon to come.

**Tuning Principles in General** will be the next and final subject to be discussed by Thomas W. Benson. This clearly understood writer will terminate his series next issue. The last article will be just as valuable as its predecessors.

**"How to Operate" Will Describe a New Receiver** next week. The set to be illustrated hasn't been on the market so very long, but has proven itself worthy of an article on how to install and operate it.

**Winding Low Loss Inductances?** See the anti-capacity cage coil support designed and used by Arthur L. Kaser. Real selective and efficient inductances can be wound using this form to be described next issue by Mr. Kaser.

Newsstands Don't Always Have One Left

WHEN YOU WANT

# Radio Digest

YOU WANT IT!

BE SURE OF YOUR WEEKLY COPY BY SUBSCRIBING NOW

SEND IN THE BLANK TODAY

Publisher Radio Digest,  
510 N. Dearborn St.,  
Chicago, Illinois.

Please find enclosed check M. O. for Five Dollars (Six, Foreign) for One Year's Subscription to Radio Digest, Illustrated.

Name .....

Address .....

City.....State .....

# Fultone

Trade Mark

### The Ford of Loud Speakers

Fultone has been thoroughly tested on regenerative, reflex, tuned radio frequency and super-heterodyne receivers and has proven its ability to handle both faint programs from distant stations and the roaring volume of the locals. This it does without distortion, without blasting and with a pleasing absence of tinny or other metallic noises.

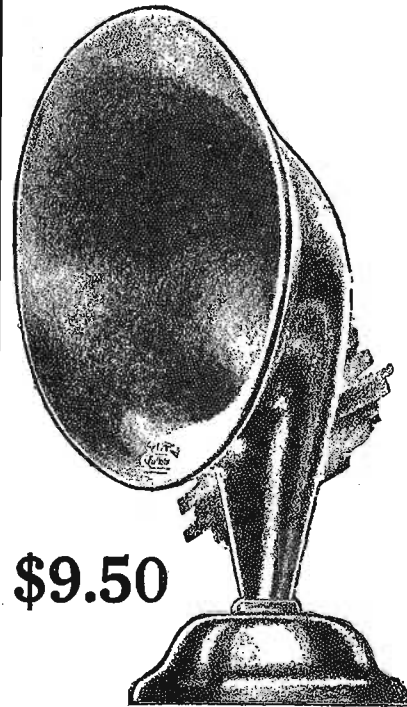

## \$9.50

If your dealer cannot supply you, send money order or check for \$9.50

### HALL & WELLS, Inc.

128 N. Wells St. Chicago, Ill.

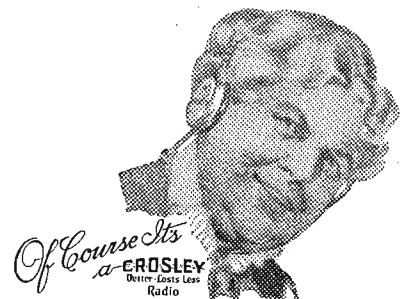

Think of the boundless delight of that dear old mother, confined to the house by the rigors of winter or the infirmities of age, when she listens in for the first time on a Crosley Radio. Imagine the joy of the kiddies, when they awaken you Christmas morning with the glad tidings that "Santa has brought us a Crosley Radio." Then decide to make this a Crosley Christmas.

There can be no gift with greater possibilities for continued happiness than a Crosley set. It carries Christmas along through the year, continually giving new thrills and happiness, and bringing pleasant thoughts of the giver.

It is a delight to operate a Crosley. The immediate response to the turn of the dials; the clearness of reception from far distant points; the real ease with which local stations may be tuned out; all help to make Crosley reception distinctive and exceptionally pleasurable. The very low cost at which this really remarkable radio performance can be obtained places Crosley sets within the reach of all—the ideal Christmas gift.

**BEFORE YOU BUY—COMPARE YOUR CHOICE WILL BE A CROSLLEY**

Crosley Regenerative Receivers are licensed under Armstrong U. S. Patent No. 1,113,149. Prices West of the Rockies, add 10%

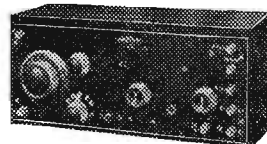

Crosley Model 52, Price \$30.00 With three tubes and Crosley Head Phones, \$45.75

For sale by good dealers everywhere

The Crosley Radio Corporation  
POWELL CROSLLEY, JR., PRES.  
12491 Sassafras St. Cincinnati  
Crosley owns and operates Broadcasting Station WLW



## ADVERTISE PRODUCT USING NEW METHOD

LISTENERS HEAR STATION WQJ BROADCAST AD

Daily Papers Publish Unique Copy Sent on Air for First Time in History

CHICAGO.—Some time ago, a play was written called "It Pays to Advertise." It has been proven without a doubt that this is really true, and Station WQJ, located in this city, recently took advantage of this fact.

On Saturday evening, November 15, during the broadcasting of the program, Jerry Sullivan, station announcer, gave newspaper advertising men the "thrill" that comes once in a lifetime. He asked that any newspapermen who might be listening in, copy the advertisement he was about to give, and insert it in his paper the following Monday for one insertion. He then read the advertisement, which was:

"Use Calumet, the world's greatest baking powder. Sales are more than two and one-half times those of any other brand. Tune in on WQJ on 448 meters and enjoy entertainment being broadcast by the Calumet Baking Powder company from the Rainbow Gardens station at Chicago."

This "ad" was to be two columns wide and ten inches deep, and to appear only in the daily papers.

Many papers besides inserting the ad, made various comments on the unique method used to "tell it to the public." This is the first of a series of novel stunts which the station will broadcast during the coming season.

Although only in operation since May, 1924, this station has been heard from coast to coast; from the far reaches of the Behring Sea in Alaska, to the Canal Zone. And the season for Radio has just begun.

Director-announcer Sullivan, is preparing to keep Radiophans tuned in to WQJ constantly, so that they will not miss any of the coming features.

### Continued Congestion Will Be Relieved Soon; Hoover

WASHINGTON, D. C.—"The past year has seen continued congestion in Radio transmission," says Secretary of Commerce Hoover in his annual report to Congress.

"The principal accomplishments of the Third Radio Conference which took place after the fiscal year now under review, were the allocation of additional channels for marine use, the limitation of marine Radio telegraphing so far as it has affected the broadcasting band, and the re-allocation of channels for broadcasting stations. I am confident that these changes will result in a great improvement in the whole Radio situation."

### Farmers Favor Service

WINNIPEG, Can.—Numerous favorable comments are being received by Station CKY, regarding the farmers' question box Service which CKY inaugurated. J. M. Black, writing from Strathclair, Manitoba, says, "I think this is excellent."

## HUNTER COLLEGE GIRLS GO IN FOR SUPER-HETS



It is a far cry from the first one tube set in the experimental laboratories at Hunter College, New York, to the above photo. But, the girls have advanced to the super stage in the Radio division. They are shown assembling and testing a new eight tube super-heterodyne receiver with which they hope to "log" the coast regularly this winter.

### LOS ANGELES COUNTY USES KNX TO EDUCATE

Public Schools Receive Regular Tuesday Morning Program

HOLLYWOOD, Calif.—KNX, "The Voice of Hollywood", the station that has gained great favor during its first few weeks of existence, has been selected by the California state board of education to conduct a series of experiments to show whether or not Radiocasting to schools is practicable.

Continuing for the balance of the school year, each Tuesday morning from 9 to 10 (Pacific time) KNX is broadcasting educational talks and lectures by prominent southern California educators. The subjects to be covered will all be on the early history of California.

A feature of the plan differing somewhat from many other attempts of this kind is that all primary schools in Los Angeles county are being equipped with suitable receiving sets, and the talk is a regularly scheduled part of the school day on each Tuesday.

### Start Movement to Establish Apparatus Standardization

WASHINGTON, D. C.—There is an apparent trend toward the standardization of Radio apparatus. Organized effort in this direction has been started in which the bureau of standards is participating. A sectional committee on standardization of apparatus and nomenclature has been organized. It has 26 members representing various producing, consuming, distributing and general Radio interests.

### Listen to Opera in Arctic Divide Camp

Prominent Writer Hears Review of Own Book

OAKLAND, Cal.—On the Arctic Divide, far north in the Canadian ice-wilds, a party of explorers, equipped with Radio, shivered and listened to grand opera produced in San Francisco, as it was being broadcast by KGO.

The enthusiasm for Radio of Lewis R. Freeman, former Stanford university tennis star, led the party to carry a set specially packed in a mule case. Despite the fact that the little set was smashed, dropped into a creek and submerged, fished out, dried out, repaired and re-hooked up, it gave excellent results.

Freeman said recently in San Francisco, as he stopped over on his way home in Pasadena, that to him the most thrilling moment of the whole journey was when he sat on the edge of a glacier and heard his own name pronounced over the air from KGO. Joseph Henry Jackson, literary editor, was reviewing a Freeman travel book on that evening.

### WJJD Claims Daylight Reach

MOOSEHEART, Ill.—New daylight broadcasting records are claimed by Ralph Shugart, engineer of the Loyal Order of the Moose station, WJJD, located here. A recent Radiocast of a football game brought congratulatory letters from Jackson, Ala., Stephens, Ark., Harrisburg, Pa., Beresford, N.D., and Oxford, Nebr.

## BROADCAST SIMPLE SYMPHONIC STRAINS

STATION WLW PROVIDES A SPECIAL FEATURE

Brief Explanation Given Before Concert Enables Listeners to Enjoy Symphony Movements More

CINCINNATI.—William Kopp, who directs the Western and Southern orchestra on Sunday night at WLW, is providing a special feature in the form of simple movements from the great symphonies which are exceedingly commendable.

It has been frequently remarked that the fortissimo passages in orchestral selections, especially when played by large orchestras, do not come through well. We fancy that Tschaiakowsky's "1812" would never broadcast as well as "The Dance of the Flowers" by the same composer, but it does not follow that all symphonic music should be barred from the microphone. As everybody knows, practically every symphony has one or two movements of a pastoral strain or a light nature.

### Picks Movement from Symphony

Working upon this idea, Mr. Kopp selects for his program each Sunday night, a movement from some great symphony which will be especially pleasing over the Radio. Thus, has he been able to give to the public such symphonic works as the second and third movements from the Beethoven Eighth Symphony and the second movement from Tschaiakowsky Sixth Symphony.

With thoughtful programming Radio listeners have every hope to be supplied with the worlds most glorious music. On the Crosley programs brief explanations make these symphonic concerts even more enjoyable.

### Promise New Results Using Beam System

Marconi Claims Operating Costs Are Greatly Reduced

LONDON.—Remarkable developments in the beam system of Radio telegraphy recently made by Senatore Guglielmo Marconi have created the greatest interest among experts throughout the British Empire. The hope is held out that by means of the new improvements to the beam system it will be possible to carry on Radio activities over long distances by day with the ease that is at present characteristic only of night transmissions.

By the beam system waves that normally would radiate over a great circle are sent in one direction, ensuring a degree of privacy hitherto impossible. Operating costs, too, are greatly reduced. Senatore Marconi achieved his recent successes by reverting to the use of short wave lengths.

Apart from achievements registered a few months ago, there have been important indications of the new progress made with the beam system. A message just received from Sydney states that Mr. Fisk of the Amalgamated Wireless company of Australia, has made exceedingly satisfactory tests of the system between England and Australia.

## RADIO IS ONLY CHAUFFEUR OF THIS AUTOMOBILE

Now it is the Radio automobile. This vehicle, designed and assembled by electrical students at the University of Illinois, is operated by a driver who sits at a distant control board. The automobile can be driven backward or forward from any distance within Radio reach. Its horn can be tooted and its lights turned on or dimmed. In tests the machine was driven by an operator a mile away.

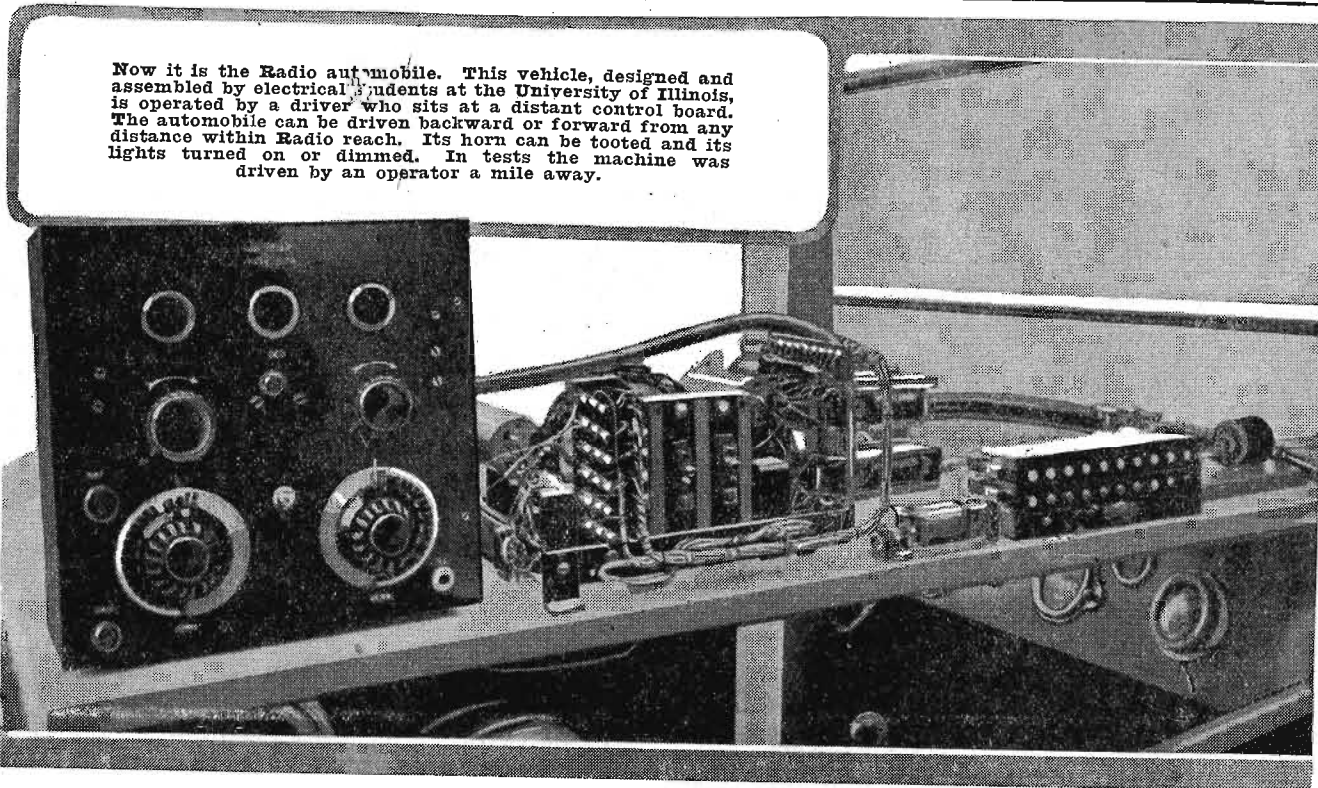



Eveready Heavy Duty "B" Battery, 45 volts. Three Fahnestock clips. Length, 8 3/16 inches; width, 4 7/16 inches; height, 7 3/16 inches; weight, 13 3/4 pounds. Price \$4.75.



*Dry "B" Batteries are more economical and more dependable than any other source of plate current!*

## REDUCE Operating Costs

THOUSANDS of people are already cutting their "B" Battery costs one-half, or even two-thirds, by using the new Eveready "B" Battery No. 770 on their heavy drain sets.

This new Eveready Heavy Duty Battery marks a marvelous advance in reducing "B" Battery costs.

If your "B" Batteries have lasted only two months on a five or six tube receiver, this Eveready Heavy Duty "B" Battery will increase the service two to three times.

Use this Eveready Heavy Duty "B" Battery on any receiving set on which the "B" Batteries last less than four months. When thus used to its full capacity, it is the cheapest as well as the best source of "B" energy ever offered.

Manufactured and guaranteed by  
**NATIONAL CARBON COMPANY, Inc.**  
 Headquarters for Radio Battery Information  
 New York San Francisco  
 Canadian National Carbon Co., Limited, Toronto, Ontario

**EVEREADY**  
**Radio Batteries**  
 —they last longer



# "Keep Growing Wiser"—Order of Hoot Owls



Interior of studio showing Mme. Edith Mason, prima donna of the Chicago Civic Opera company, with her husband, Polacco, at the piano, broadcasting.

Richard J. Haller, better known as "Dick," who is director-announcer at Station KGW. He is holder of the Grand Goat, used in the Hoot Owl initiations.

AT TEN THIRTY on Friday evenings, listeners to KGW, the Morning Oregonian station of Portland, Oregon, may hear any of the following: "Brother Hoot Owls, seven times the sun has set since we gathered in the old Radioak in the home roost of the Oregonian tower\*\*\*\*\*"

And a noise frequently interrupts with:

"Just as I thought\*\*\*\*\*"

Then:

"Whom shall we initiate tonight?" It may be President Coolidge, or Lieutenant Kelly, who preceded the World Fliers, a concert pianist appearing at a local theater or a new business firm opening with an advertising campaign of international or national celebrities, but the initiation proceeds with the same fervor.

The Friday night broadcasters from KGW are known as the Hoot Owls. Their names include prominent business and professional men of Portland. There are only eight of the degree team. This degree team works each week for the furtherance of Portland fun and publicity. The Grand Screech of the team is Charles Berg, one of Portland's leading ready-to-wear merchants; others are as representative.

The first thing one hears over the air from KGW at ten-thirty on Fridays is the strains of an old fashioned caliope. Is the circus actually on the air? You wait for further announcement—and find that it is the Right Reverend Walter Taylor Sumner, Bishop of Oregon, and formerly of Chicago, where as "Dean Sumner" he was notable in his utterances on health. It may be his assistants, but if possible Bishop Sumner attends the Hoot Owls' programs in person and plays his part.



The degree team of the KGW, "Keep Growing Wiser" order of Hoot Owls. Every Friday night they are on the air, assisted by Dick Haller and Bishop Sumner at the caliope. Clockwise they are as follows: Charles F. Berg, grand screech; Frank J. Sardam (Uncle Sid), grand scream; Alex

Relly, grand piano; Henry Metzger, grand slam; Dick Haller, holder

of the grand goat; Barney Goldstein, grand schmoos; "Tige" Reynolds, grand sketch; Steve Juhasz, grand slumber; Bishop Walter Sumner, grand sermon, is not in the picture. The owl is the official emblem of the Hoot Owls, and was designed by C. L. Smith.

Not long ago Bishop Sumner conducted a church service from KGW and opened the service with a hymn played on the caliope. He is the only bishop in the whole world known to play a caliope. He usually plays such modern

favorites as "Annie Rooney" and "Side-walks of New York," for Friday night listeners.

The order of Hoot Owls carries its motto in the call letters of the station, for KGW, they tell you, really stands for the "Keep Growing Wiser" order of Hoot Owls.

This night session, which sound, in name only, like the various night birds and Radiowls of middle west and southern stations, is unique in its real purpose, for the members of its degree team are permanent workers in Portland's publicity plan and through these jolly programs, Portland is advertised unusually well. The membership roster contains names of listeners in, but the real members who put on the weekly programs resemble in titles, an official lodge organization. Its official emblem, the owl perched on the Oregonian Radio tower, was designed by C. L. Smith of the Oregonian art department.

Richard J. Haller, known to everyone in Portland and to Radio listeners as Dick Haller, is a war veteran who, after serving overseas and a brief reportorial season on a New York newspaper, came out to Portland to report for the Morning Oregonian. When the station was opened, Haller was placed in charge and with the operator and office assistant, who handles the children's evening story program, continues to interest KGW listeners remarkably well.

Not long ago Haller heard of a group of old time fiddlers in Forest Grove, about a hundred (Continued on page 8)



Walker brothers' concert in progress. They are "Old Time Fiddlers" of Forest Grove, Oregon. Left to right, William G., Samuel A., Raleigh C. and Charles L. Walker.

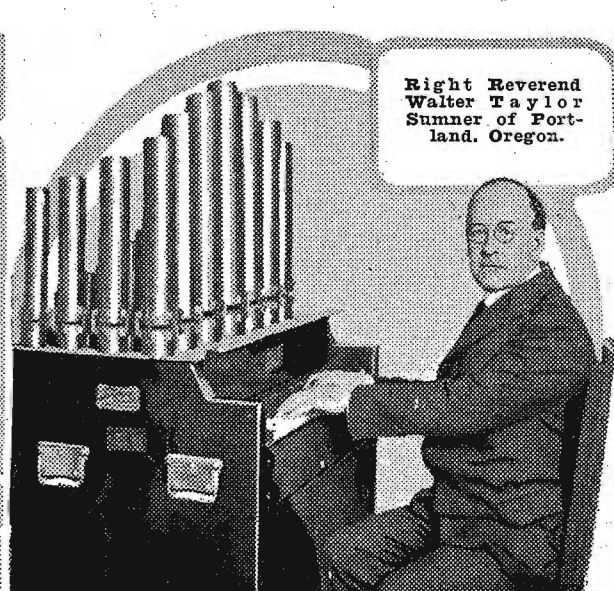

Right Reverend Walter Taylor Sumner of Portland, Oregon.

"Masterpiece is a wonder-  
 We have tried them all!"  
 "California on Loud Speaker  
 from Plainfield, N.J."  
 "51 Stations in 2 hours."  
 "Best set ever put on the market"  
 "Beats any set at \$200."  
 "Can I be your agent?"  
 "It is simply marvelous"

# Thousands of

Unsolicited letters of praise prove conclusively that the Freshman Masterpiece is the equal, if not the superior, of any five tube receiver in the world—regardless of price. The statements above, taken from letters received, give a general idea of the tremendous hold that this remarkable set has obtained.

Made of the finest low loss materials and in a beautiful genuine solid mahogany cabinet, it is attractive enough for the most pretentious room, and at sixty dollars, economical enough for the most modest. Combines every single point essential to the perfect receiver. Real distance reception without that squealing and howling. So selective that once a station is picked up—it can be brought in again on the same points on the dials, whenever you want it. And what's more—

*IT'S THE EASIEST OF ALL SETS TO OPERATE*

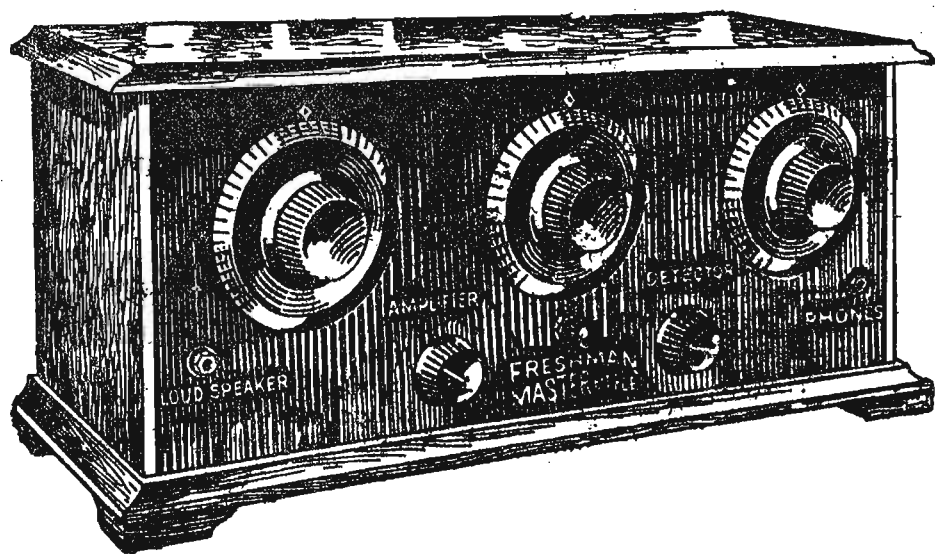

**\$60.**

**THE GREATEST VALUE  
EVER OFFERED IN A  
RADIO RECEIVING SET**

**FRESHMAN  
MASTERPIECE**

**5 TUBE TUNED  
RADIO FREQUENCY SET**

*Ask Your Dealer to Install One in Your Home*

All genuine Freshman Masterpiece Sets have a serial number and trade-mark riveted on the sub-panel. The Receiver is not guaranteed if number has been removed or tampered with.

**Chas. Freshman Co. Inc.**  
*Radio & Condenser Products*  
 106 SEVENTH AVENUE, NEW YORK CITY

IF YOU WANT TO BUILD IT YOUR-  
 SELF, YOU CAN BUY THE FRESH-  
 MAN MASTERPIECE KIT. ASK  
 YOUR DEALER.



# AMERICAN STATIONS REGISTER IN EUROPE

## WGY MOST CONSISTENT TO REACH THE CONTINENT

### CKAC Also Makes Impression on Fans —Heavy Mail Received by Both Stations

SCHENECTADY, N. Y.—That the day of transatlantic broadcasting with a fair degree of reliability and with signals of good quality and loud speaker volume, is not far off, is revealed by the heavy European correspondence of Station WGY, located in this city.

On October 22, WGY received sixty-eight letters from fans located in England, Ireland, Scotland and Wales. The European fans, like all fans, are anxious to get the call letters of the station received. Those who picked up the church services broadcast at about 12:30 a. m., British time, waited until nearly 2 o'clock for the call letters "WGY" to come through.

#### Doesn't Like Sermons

A Sheffield man remarked: "What interminable sermons you endure in America. But perhaps they seem longer by the time they reach here." At 1 o'clock in the morning a sermon probably seems longer.

Station CKAC in Montreal, has reported receiving numerous letters from European fans throughout the past month complimenting them on their transmission and the quality of programs broadcast.

On November 16, a special show was broadcast to the European listeners. Featured on this program was the orchestra from the French Line steamship S. S. Paris. These musicians were brought from New York to Montreal so that they could play French music to their fellow countrymen who happened to be listening in to CKAC.

Many other stations are completing arrangements for broadcasting special European programs in the near future.

#### English Breakfast; Canadian Music

Enjoying a Canadian midnight show, shortly before breakfast, to the call of a sizzling slice of bacon, which filled the parlor with its known appetizing aroma, was the recent unique experience of one, Arnold, of Hempstead, London, England, and possibly of many others, on Wednesday morning.

## UNCLE JOHN WITH AN ASSISTANT

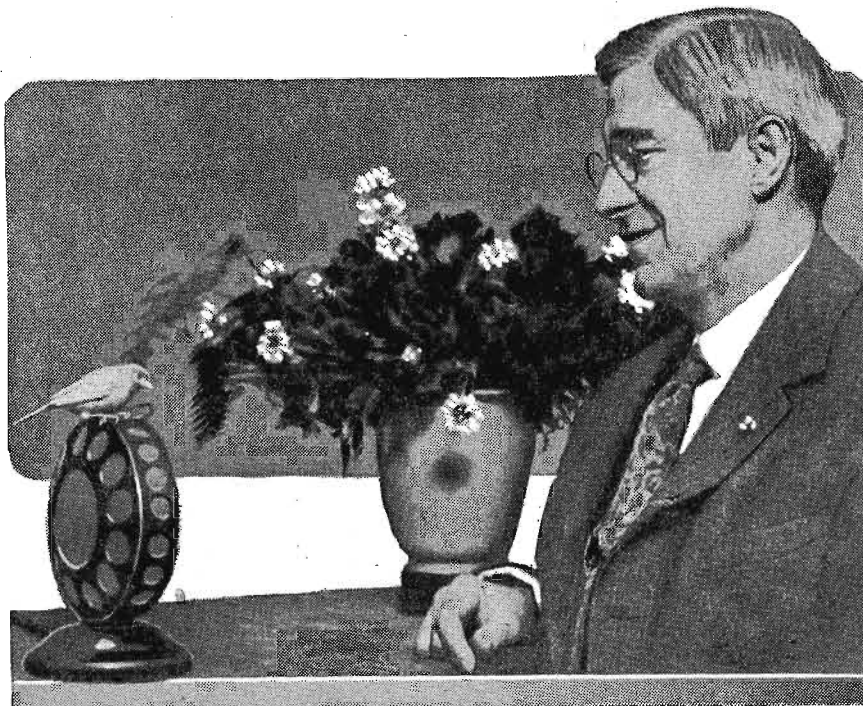

Uncle John Daggett, sunny California's most popular announcer, at Station KHJ. This station has three famous canaries, known as Radio Kindness, Radio Happiness and Radio Joy. The latter is singing to listeners while astride "mike's" case.

Station WKAQ, operated by the Radio Corporation of Porto Rico, has been conducting a series of tests with the "Radio Iberica" in Spain. Not only has the reception of the station been very clear in Spain, but also in more distant parts of Europe.

### Picadilly Theater Furnishes Wonderful Musical Program

NEW YORK.—Station WGBS is now broadcasting a special program from the Picadilly theater in this city. A special studio has been built above the auditorium, where numbers will be broadcast from time to time under the direction of Mischa Guterson, famous conductor.

### Vaughn DeLeath on Tour; To Give Pictures for Log

NEW YORK.—Vaughn DeLeath, well known to Radiophans, has returned to "Laugh, Clown, Laugh" company which has just gone on tour. Miss DeLeath interprets the role of an opera singer, Signora Calvaro.

When the show goes on tour, she will continue to broadcast her songs from the various stations along the way.

The Radiophan who keeps the most accurate account of her broadcasts will be rewarded with a large portrait of her. To the ten who are next best, a regular size picture will be given. Her schedule will be kept a secret.

## ACCOMPLISHMENTS ARE EASY FOR KARL

NORFOLK, Nebr.—All prodigies do not reside in the large cities; nor man the microphones of super stations. Karl Stefan, chief announcer at WJAG, the Norfolk Daily News, is one of the exceptions. How does it happen that WJAG, a 250-watt station in a 9,000 population city, scores "beat" after beat on the larger stations in Nebraska and Missouri in the dissemination of news, football and sports bulletins?



Karl Stefan

Well, get a Karl Stefan and it's easy. Mr. Stefan is accomplished. He understands and easily reads both Morse and Continental code. As newspaper's telegraph sounder ticks away, Stephan puts the ticks in the English language before the microphone without even going to the trouble to transcribe on paper.

So he gains speed and scoops rival and larger stations.

That's not all. He is originator of "The Printer's Devil," prominent and much-admired character at WJAG, "Norfolk in Nebraska, Home of 'Old King Corn,'" and head of the "WJAG Radio Family."

Besides he is city editor on the Daily News, Radio editor and sports writer. Maybe you think he hasn't any spare time. If you do, you're wrong, for in his spare moments—

He has traveled around the world, and speaks to interpreter exactness: Bohemian, German, Spanish.

Which goes to show that you don't have to have 500 watts in your antenna to become prominent.

### France Converses with Argentine

PARIS.—M. Leon Deloy, the French amateur, has been in two-way communication with Mr. Carlos Braggio (DA8 ex CB8) of Bernal, near Buenos Aires. M. Deloy used an 86-meter wave length for transmission, and the intensity in his aperiodic antenna was only some hundredths of an ampere.

# Why it is Better

THE picture tells the story—seven practical, sensible reasons why Federal sockets should be in your "pet" hook-up.

Federal sockets are but another evidence of the care and engineering skill used in designing and making Federal Standard Radio Parts.

There are over 130 standard parts bearing the Federal iron-clad performance guarantee—their use means—"Balanced Circuits" with better performance.

FEDERAL TELEPHONE & TELEGRAPH COMPANY  
BUFFALO, N. Y.

Boston New York Philadelphia Pittsburgh Chicago  
San Francisco Bridgeburg, Canada



# Federal

Standard RADIO Products

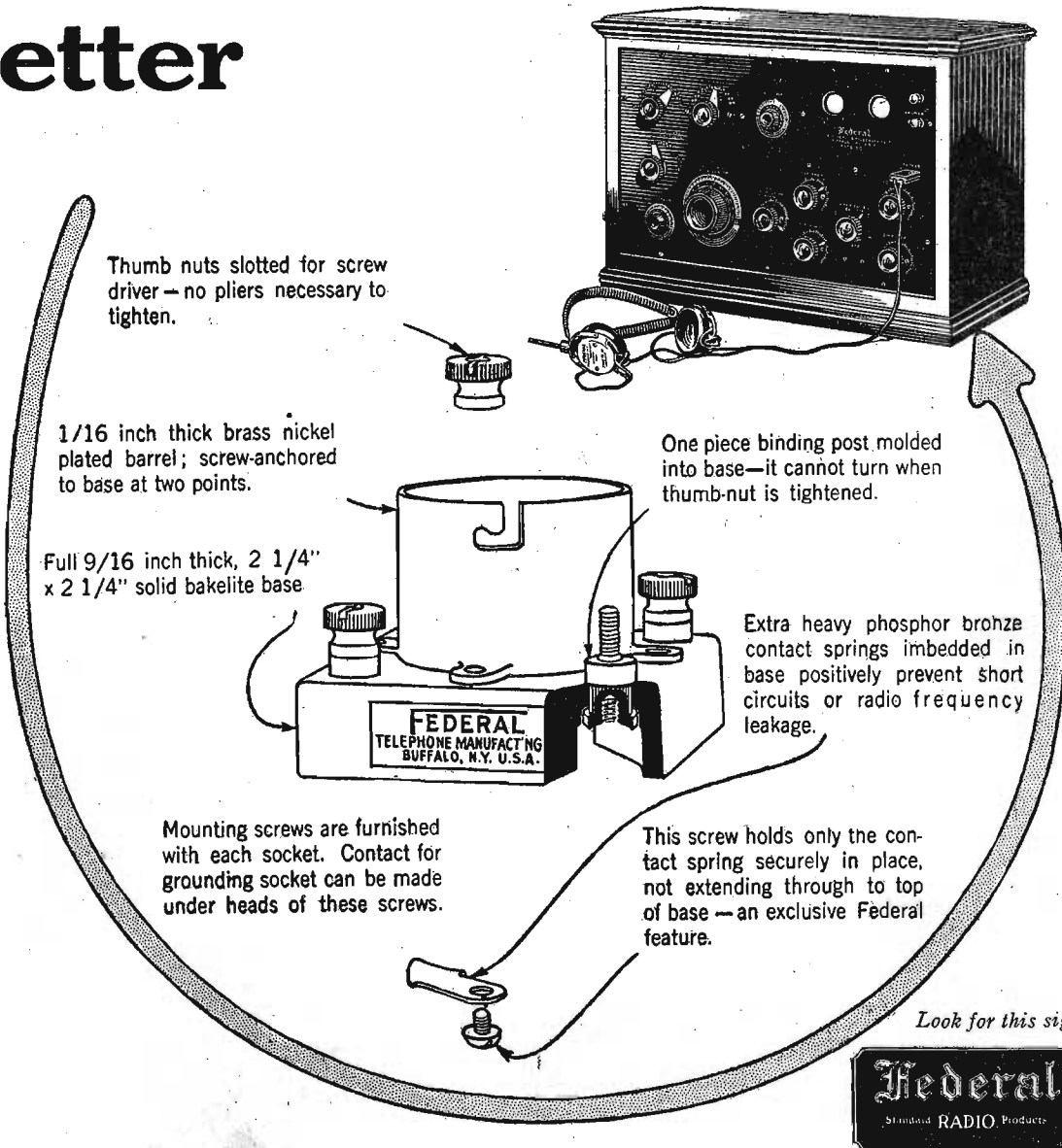

Look for this sign



THE ANTENNA BROTHERS

Spir L. and Lew P.

High Finance

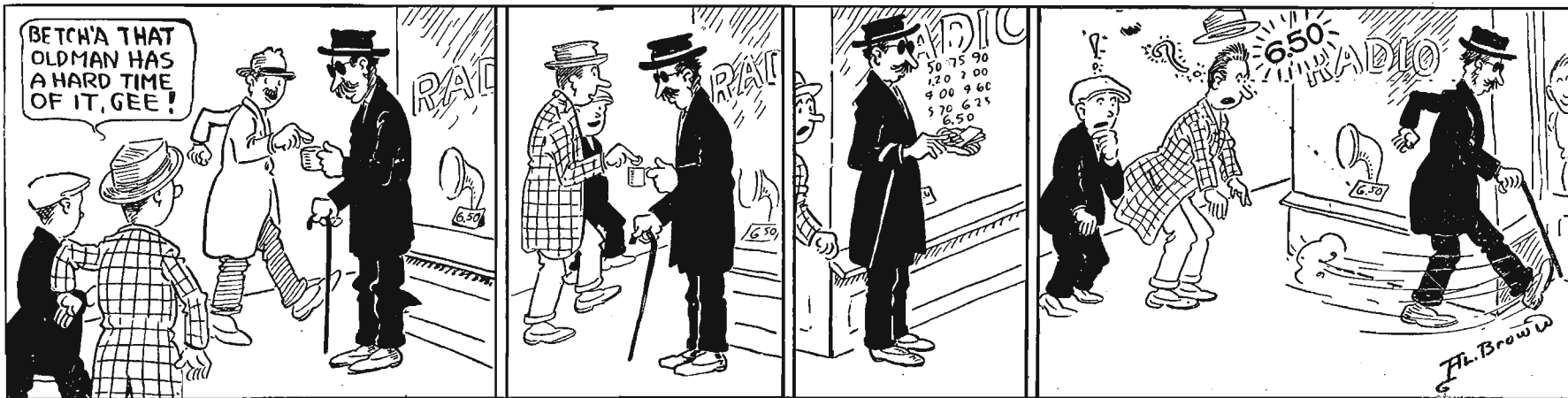

European Notes

Englishmen so liked the London Zoo broadcast not long ago, that a repetition of the program was given recently.

Senator Paul Dupuy, of France, has erected a private broadcasting station on the top of Pic du Midi, in the Pyrenees, and intends to study Radio phenomena. He broadcast his inaugural address recently.

Station EAJL, Barcelona, Spain, is now conducting tests on 325 meters, using 100-watts power. These are made between 6 and 7, and 9 and 11 p. m., Barcelona time. After completing the trials, the operas given at the Liceo theater, Barcelona, will be broadcast.

The Minister of Posts and Telegraphs of the Irish Dail has prepared complete plans for an Irish broadcasting service, and is now only awaiting funds to carry it through. Amateur transmitting regulations have been made less strict and practically parallel those of England.

A 300-meter, 200-watt broadcaster is planned for Agen, in the department of

Lot-et-Garonne, France. Concerts, lectures and news will be a part of the program.

The Lausanne, Switzerland, Radiocast station was reopened recently, after being temporarily closed for repairs.

Censorship of Radio programs is being seriously considered by the French press. The German plan of controlling all broadcasting stations is cited as an example. In several French homes children have been severely scared and shocked by the intense realism of unannounced Radio dramas. This is one of several reasons given.

England Hears U. S. Elections

LONDON.—The British Broadcasting company announce from 2LO that American presidential election results were picked up by them in the early hours of the morning of November 5. About ten results conveying specific figures were received via KDKA and these were followed by a five minutes program of music.

Marconi Station to Be 1RO

ROME.—The Marconi broadcasting station at Rome has been allocated the call sign 1RO.

KGW, PORTLAND'S BEST

(Continued from page 5)

miles from Portland and wrote them, inviting them to perform from KGW. Their appearance won recognition everywhere and constant calls for reappearance. These four Walker brothers, William, Samuel, Raleigh and Charles, playing three violins and piano, had not played for the public since the old style dances went into the discard. Theirs was not the music for jazz. But Haller and the Oregonian believe that the public really wants the old time music, ballads.

The old songs of twenty to thirty years ago are welcome at KGW, and the reaction comes in floods of requests for the Walker brothers all over the state. Now they have become dance and concert players again and through the Radio have come into their own.

Operatic stars in Portland often appear at KGW and a recent Radio appearance of Edith Mason, the soprano prima donna and her illustrious husband, Emil Polacco, conductor of the Chicago Civic Opera company, at the piano, brought her before the thousands of shut-

ins and far distant listeners which only Radio can reach.

KGW is a station owned and operated by the newspaper, the official organ of news and service of a community. The Morning Oregonian is a representative newspaper of the great west coast and with Thomas its Radio editor, Dick Haller keeps the standard of KGW as high as its tower studio and the lofty roosts of its famous Hoot Owls.

Harmonica Contest Held at Station KFNF Pleases Fans

SHENANDOAH, Iowa.—Station KFNF, located in this city, recently held a harmonica contest. It was conducted along the same lines as the well-known "Old Fiddlers" contest.

The Radiophans who are listening, write in and vote for the person that they think is the best. The winner receiving the reward offered.

The next harmonica contest will be held on December 17, tune in to KFNF on 266 meters and listen to the various musicians perform on the old harmonicas.

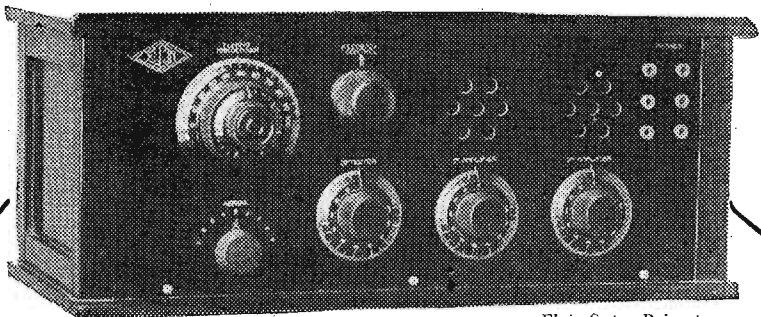

Elgin Super Reinartz 2LO Model Tuner

The Set That Heard London

This astonishing reception was accomplished twice, in two separate cities of the United States during the trans-Atlantic tests last season.

The Elgin Super-Reinartz, 2LO Model Tuner spans the continent nightly at the hands of thousands of Radiophans. Through this highly efficient circuit amazing reception has been obtained. New York is entertained by KGO and Houston, Texas, listens in on WLAG with surprising regularity.

ELGIN Super-Reinartz "The Ford of Radio"

will give you the DX records it has brought to others.

You must learn more about this wonder circuit at once!

Mail the coupon TODAY with your name and address and we will send—FREE of charge—the complete working diagram of the Elgin Super-Reinartz, 2LO Model. There are no obligations, of course.

Dealers: Write for Proposition

Free Coupon

Elgin Radio Supply Co. Dept. A, 207 E. Chicago St., ELGIN, ILL.

Send at once the working drawings of the ELGIN SUPER-REINARTZ, 2LO MODEL TUNER—The Set That Heard London. I am enclosing stamp to cover postage.

Name .....

Address .....

(PLEASE PRINT IN PENCIL)

Herald MODEL B



The Big, Clear Voice of Radio!

\$18

A NEW Herald—clear—loud—with a tone that is wonderfully mellow and sweet. Height 25 inches. Bell 12 inches. Fibre horn and art metal base. No batteries required. No adjustment necessary. Hear the Herald Model B at your dealer's.

Herald Electric Co., Inc. 113 Fourth Avenue, New York



# An Eight Dollar Crystal Set with Selectivity

## Part II—Panel Layout and List of Parts

By Victor Andre Matteson, A. I. A.

IT MAY be found advisable to add to or remove one or two turns of wire from the variometer windings, in order to make the primary circuit tune properly throughout the entire broadcasting range of wave-lengths, by one-half revolution of the stator. This depends upon the exact length of the aerial and ground wire, and also certain characteristics of the set itself, and can best be determined by experiment. It also may be found that the set will tune better with but two primary turns around the secondary. The signals will be louder with more turns, but the tuning will be less selective. If a ready-made variometer is used these windings will probably have to be changed to suit the conditions just described.

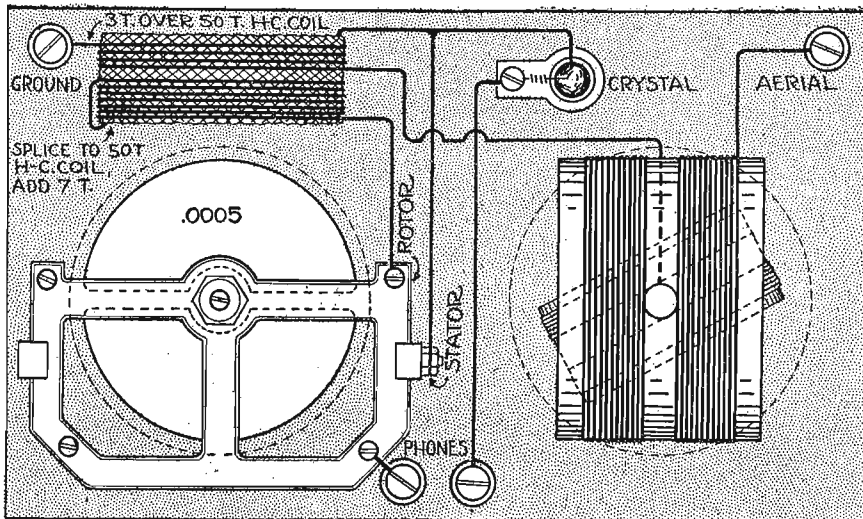

List of Parts	
1 Variable condenser .0005 mfd.....	\$ 5.00
1 Mounted crystal detector.....	1.00
1 Honeycomb, 50-turn.....	.80
2 Dials, 3".....	.60
Cardboard tubing.....	.40
Wire 1/2 lb., No. 24 dcc.....	.40
4 Binding posts.....	.40
1 Panel 5"x9".....	1.40
	<b>\$10.00</b>
Accessories Required	
1 Pair head receivers.....	\$ 7.00
1 Ground clamp.....	.20
1 Coil antenna wire, 150 ft.....	1.20
Lead-in wire, rubber covered.....	.80
4 Antenna insulators.....	.20
1 S. P. D. T. knife switch.....	.40
	<b>\$9.80</b>

the honeycomb windings. These may be ordinary concentric turns. This coil is fixed in position and located in the set as far away as possible from the variometer, and with its axis at right angles to the variometer shaft; also keep it as far from the field of the condenser as practical. The condenser is connected across this coil and tunes it.

If the condenser does not tune practically throughout its entire range, from the lowest to the highest broadcasting wave lengths, add or remove a few of the extra turns given the honeycomb coil. When the number of turns on the coils of the variometer and those of the secondary coil are correct, and the aerial is of proper length, both dials should tune approximately together at nearly the same dial reading, for each wave length throughout the scale. Thus, 286 meters should tune on both dials at approximately 15, and 536 meters at about 85 or 90. A certain amount of juggling of

the number of turns of all coils may be necessary in order to accomplish this, for reasons before given.

The wires may be held in place on the coils and tubes by the use of a little Radio cement or sealing wax.

### Crystal to Be Used

Any high grade mounted crystal will work if the crystal is sensitive, but preference should be given to that type of mounting with the crystal enclosed, protected from moisture and dust, and with an adjustment that will not be easily disturbed. The adjusting knob only, need appear on the panel. Once set at maximum strength of signal, the adjustment should be left alone, until through jar it is in need of readjustment.

The set is wired as indicated in the diagram, and this is very simple. Num-

ber 14 tinned copper wire may be used, but the same wire used for winding the coils will answer equally as well. Make the leads as short and direct as possible, and keep them separated from each other. Solder all connections.

Efficient phones are particularly desirable for the comparatively weak signals of a crystal receiver. As they will last a long time, and can be used with any set, it is economy to buy the best. Binding posts are shown for the phone connections, but a jack and plug may be substituted, and is somewhat more convenient.

### Tuning

If properly made, and coils properly proportioned, the set is quite sensitive to tuning. Both dials should be manipulated at the same time until the signal is heard, keeping the readings of both the same, then further adjust each dial for maximum signal strength. If the aerial and ground are not changed, the set will always tune in the same station at the same reading, which can be logged. If not closer to a broadcasting station than about a mile and a half, there should be no trouble in tuning in any station within the radius of eight or ten miles, without serious interference from other stations differing by not less than 20 meters in wave length.

### Amplification

The set can be connected to an external audio frequency amplifier, or it can be built, if desired, with one or two stages of audio frequency, using dry cell tubes, incorporated in the set. Many descriptions of efficient audio frequency amplifiers have been published. To connect the crystal circuit to the amplifier circuit, simply consider the primary connections of the first A. F. transformer as a substitute for the two phone connections, and connect as a substitute for the phones. Try reversing these connections to get maximum results. One stage only, of

(Continued on page 10)

The primary circuit consists of the aerial, lead-in, the variometer, the turns around secondary and the ground, all of which influence the tuning.

### Secondary Coil

The secondary tuning coil consists of the 50-turn honeycomb coil to which must be added about 7 more turns wound on the outside in the same direction as

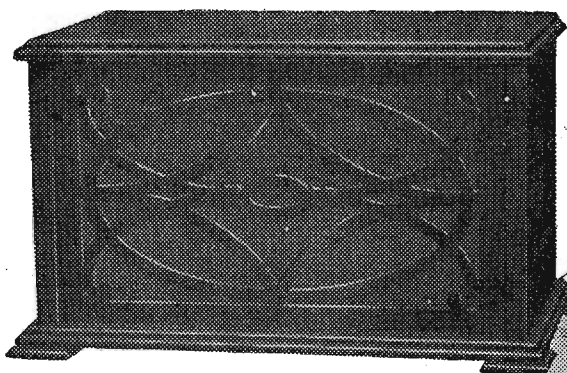

Model "C"  
Cabinet Type  
\$30

## The New Cabinet Model

For those who admire the full, round, musical voice of the Audiophone, but prefer a cabinet design, we have brought out this splendid model.

The case is real mahogany. The design is in keeping with the best furnishings. The size, 17x10x10 1/4, is just right for the top of your phonograph or your receiving set. The voice of the Audiophone is

### Not a "Phone Unit"

It is a highly developed, electro-magnetic tone mechanism which reproduces with natural quality in most powerful tones, yet has a sensitiveness equal to any loud speaker developed.

The Bristol line includes five Audiophones priced from \$12.50 to \$30.00. If not at your dealer's write for Bulletin AY-3022.

The Bristol Co., Waterbury, Conn.

**Bristol**  
**AUDIOPHONE** LOUD SPEAKER

The Voice of the Audiophone



Model "S"  
Audiophone  
\$25  
Rubber horn 1 1/4" diameter. Velvet mat. finish of mottled bronze and gold; classic base.

# EISEMANN

ELECTRICAL EQUIPMENT

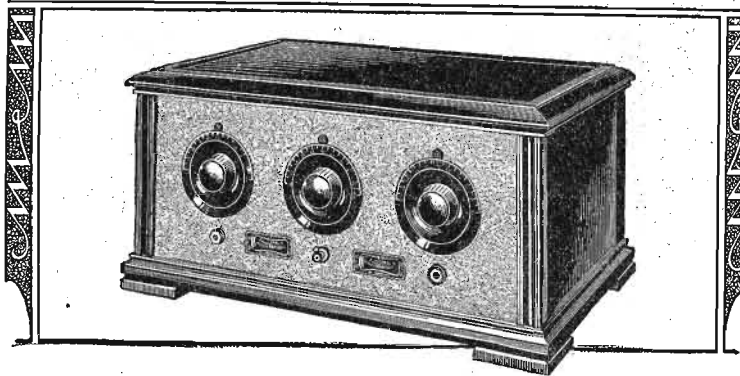

## Type 6-D Broadcast Receiver

Non-oscillating ~ Non-radiating

### SPECIFICATIONS

- Circuit:** Two stages of tuned radio frequency, detector and two stages of audio frequency. Non-oscillating.
- Tubes:** Five.
- Batteries:** Storage or dry-cells.
- Cables:** Complete set supplied.
- Wave Lengths:** 200 to 600 meters, with uniform efficiency of reception.
- Panel:** Aluminum. Black crystal-line finish.
- Dials:** Sunken design.
- Rheostats:** Adequate resistance for all standard base tubes.
- Condensers:** Single bearing, low leakage loss.
- Sockets:** Suspended on cushion springs.
- Cabinet:** Mahogany, with space for "B" batteries.

Price \$125.00  
without accessories

A modern receiver to meet the exacting requirements of experienced operators. Extraordinary selectivity, range, volume, clarity and ease of tuning.

EISEMANN MAGNETO CORPORATION  
165 Broadway, New York

Authorized Distributors



in Principal Cities

AN EVENING AT HOME WITH THE LISTENER IN

(SEE INSTRUCTIONS FOR USE BELOW)

Table with columns: Station and City, Met., Saturday, Sunday, Monday, Tuesday, Wednesday, Thursday, Friday. Lists broadcast schedules for various stations across the country.

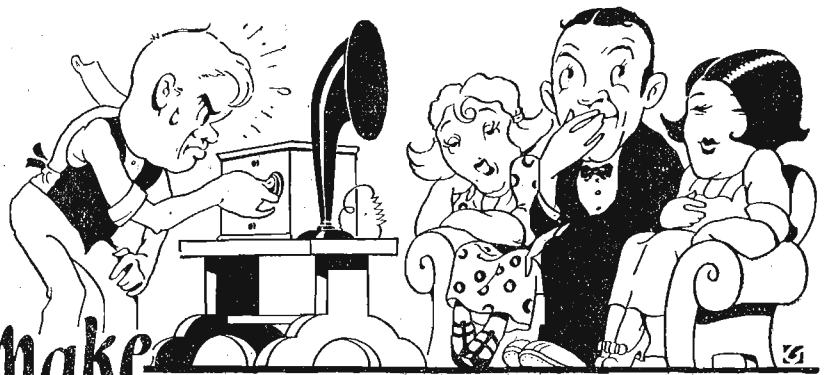

Make dumb Loud Speakers talk!

Don't blame the circuit or yourself if only noise comes from your loud speaker. Hilco apparatus makes the dumbest loud speaker talk.

The Hilco Laboratories contain special equipment of marvelous accuracy for determining whether new circuits and apparatus developed by Hilco research engineers will give maximum satisfaction.

Ever striving for perfection, Hilco developed a new type of Fixed Condenser, guaranteed accurate within 5% of rating; the famous 7 tube Super - Hilco - Dyne Kit, enabling anyone to construct at a moderate cost, radios' most superb receiver; the Hilco Lo - Loss Tuned Radio Frequency Kit and the Hilcoflex Kit, containing essential parts for building real efficient 5 and 3 tube sets at little cost; the Hilco Multiformer perfecting the Reflex and Neutrodyne when used as replacement coils.

When you buy Hilco apparatus for improving your present receiver or the construction of a new one you are getting the latest in scientific radio apparatus that is distinctively different and superior in efficiency and appearance.

Literature describing Hilco products free—Blue Prints of circuits sent at actual mailing cost of 10c.

Address Dept. 10 A.E. HILL MFG. CO. Atlanta Georgia

Ask Your Dealer about Hilco products, especially

- Super-Hilco-Dyne . . . \$30.00
Lo-Loss T.R.F. Hilco Kit 17.50
Hilcoflex Kit . . . . . 8.50
Hilco Multiformers . . . . 2.25
Hilco Fixed Condenser.
Hilco Super Het Replacement parts for perfecting Super Hets.

WRITE FOR DESCRIPTIVE MATTER

Instructions for Use.—All the hours above are given in Central Standard Time. If your city uses Eastern Time, add one hour to each of the periods stated; if your city uses Mountain Time, subtract one hour; if your city uses Pacific Time, subtract two hours. This table includes only the evening Radiocasts, and, on Sunday, the late afternoon program.

STATIONS IN ORDER OF WAVE LENGTHS USED

Table with columns: Meters, Call, Meters, Call, Meters, Call, Meters, Call, Meters, Call, Meters, Call. Lists stations grouped by wavelength.

\$8 CRYSTAL SET

(Continued from page 9) properly built audio frequency amplification, with a good UV-199 tube, will operate a loud speaker with sufficient power for a small room.

Patents Issued on Vacuum Tube of New Construction

WASHINGTON, D. C.—The U. S. patent office issued here recently an important Radio patent on the vacuum tube. The patent covers the use of stamped metal grids and plates, and the type of tube which eliminates the spiral wire grid.



# CONCERTINA ORCHESTRA AT WAAW

## Saturday, December 6

Saturday, silent night for: CHNC, CKY, KFAC, KFDM, KFGZ, KIS, KOB, CAY, WCB, WCX, WDBY, WEAQ, WEEI, WHA, WHAA, VHE, WHO, WJAX, WKAQ, WLL, WNN, WOO, WOS, WWJ.

CKAC, Montreal, Can. (Eastern, 425), 7 p. m., kiddies' stories in French and English; 7:30, Rex Battle and his Mount Royal hotel concert ensemble; 8:30, "Black Cat Night," Charles Marchand, Alberic Bourgeois, Camille Bernard, Ernest Patience; 10:30, Joseph C. Smith and his dance orchestra.  
KFI, Los Angeles, Calif. (Pacific, 469), 7-7:45 p. m., Nighthawk's dance orchestra; 7:45-8, book chat; 8-9, Oriental song recital, Althea Oliver, mezzo-soprano; 9-10, Examiner: Radio show program presenting movie stars; 10-11, Packard Radio club.  
KFNH, Shenandoah, Ia. (Central, 266), 7:30 p. m., concert, artists, Mt. Etna; 10:30, request program, Seedhouse bunch.  
KFGX, Seattle, Wash. (Pacific, 283), 7-7:45 p. m., children's entertainment; 8-9, Ray Robinson and his Bagdad orchestra; 10-11, orchestra.

orchestra; 7:30, Uncle Kaybee; 7:45, special feature; 8:30, musical program, Stetson-Oxford entertainers.  
WCAL, Northfield, Minn. (Central, 360), 12 midnight, musicale.  
WCAP, Washington, D. C. (Eastern, 469), 1:45 p. m., Army-Marine football game.  
WCAU, Philadelphia, Pa. (Eastern, 278), 6 p. m., Meyer Davis orchestra, Hotel Pennsylvania; 8, recital.  
WCAY, Milwaukee, Wis. (Central, 266), 8 p. m., Hole-proof Hosiery night; Jean Hammond's Tune Tinklers; Enclil Burdick, tenor; Mrs. George Ziegler, soprano.  
WCCO, Minneapolis-St. Paul, Minn. (Central, 417), 8 p. m., lecture hour; 8:30, musical program; 9:30, dance program, Original Geo. Osborn's Nicollet Hotel orchestra.  
WCX, Detroit, Mich. (Eastern, 517), 6 p. m., dinner concert, Hotel Tullier.  
WDAF, Kansas City, Mo. (Central, 411), 6-7 p. m., school of the air, piano-tuning-in number on the Duo-Art; the Tell-Me-a-Story Lady; music, Hotel Muehlebach Trianon ensemble; 11:45-1 a. m., Nighthawk frolic, the "Merry Old Chief" and the Plantation players.  
WDAR, Philadelphia, Pa. (Eastern, 395), 7:30 p. m., Dream Daddy's bedtime stories.  
WEAF, New York, N. Y. (Eastern, 492), 6-7 p. m., dinner music, Waldorf-Astoria hotel; 7:30-7:50, boys' stories, Fred J. Turner; 8-8:50, May Singhi Breen

## Headliners of the Week

**S**ATURDAY afternoon the football season ends with the Army and Marine football game. Anyone remembering the valiant record of the Marines and the soldiers during the war will want to watch the outcome of this struggle.

In the evening the cats in Montreal, providing they are black, will gather at CKAC. Do not hesitate to tune in because of previous experience with cats. This program will be catty in an unusual way. Another unique feature of this night will be the famous concertina orchestra at WAAW.

The Chicago Sunday Evening club will have the pleasure of listening to Prof. S. Angus of Sidney, Australia, Sunday. This talk may be enjoyed by the Radiophan by dialing for KYW.

The Monday program of WEAF will certainly drive away the traditional blues. The Three Peasants, the famous A and P Gypsies, and the Bud Fisher Happy players radiate pep and enthusiasm.

Massenet's grand opera "Cinderella," which is seldom heard, will be

the musical feature this Tuesday at KGO, Oakland. Lillian Birmingham and Carl Anderson are the directors. Wilda Wilson Church, the dramatic director of this station, will read the fairy tale. An entertaining program also characterizes this evening at WEEI, Boston. President Otis Emerson Dunham of Page and Shaw fame will be interviewed by Hap Myers.

Wednesday WLW, one of the pioneers of the Radio drama, will put on the comedy "The Joy of Living." This station was one of the first to perfect the stage properties of the sightless drama.

Mrs. John E. Harmon of New Albany, Indiana, has been putting on programs at WHAS for over a year. These are always well organized and pleasing to the ears. Tune in Thursday.

WHA will broadcast the first Christmas cantata Friday. The University Methodist church choir under the direction of Prof. L. L. Ittis will remind you that Christmas is near and there are only ten more shopping days.



Janet Malbon (above) is a popular soprano on the Pacific coast and helps to make the Golden Gate famous by singing at KFO, San Francisco. Erwin Bajarksy (right) is a popular singer appearing at all the Chicago stations. He will sing this week at WTAS.



Alvin Heins, well known Kansas City soprano, appears at WDAF Friday, December 12.



KFSG, Los Angeles, Calif. (Pacific, 278), 10:30-11:30 a. m., sunshine hour program, organ music; 3:30-4:30 p. m., impromptu; G. N. Nichols, Roy Reid Brignall and others; 7:30-9:30, Auditorium service, Aimee Semple McPherson, evangelist.  
KGO, Oakland, Calif. (Pacific, 312), 8 p. m., orchestra. Technical High school, Herman Trutner, Jr., director; Glenn Chamberlain, tenor; Madeline O'Brien, soprano; Louis Council, baritone; Hazel Nichols, pianist; "The Challenge of the New Generation," Rabbi Louis I. Newman, Herman Trutner, Jr., violinist, French horn soloist; 10-1, Henry Hailestead's orchestra.  
KGW, Portland, Ore. (Pacific, 492), 10 p. m., dance music, George Olsen's Metropolitan orchestra.  
KHJ, Los Angeles, Calif. (Pacific, 395), 12:30 p. m., Virgil Springer, basso; 2:30-5:30, Charlie Wellman's Saturday afternoon frolic; 6-6:30, Art Hickman's concert orchestra; 6:30-7:30, children's program: seven juveniles, bedtime story, Uncle John; 7:30-8, "Care of Body," Dr. Phillip M. Lowell; 8-10, feature program presented by Dr. A. Zimmerman, Immanuel male quartet; 10-11, Earl Burnett's dance orchestra.  
KNX, Hollywood, Calif. (Pacific, 337), 2:30 p. m., play-by-play broadcast of Syracuse-U. S. C. football game; 6-7:30, dinner hour music; 8-10, feature program; 10-11, Abe Lyman's Coconut Grove orchestra from Ambassador hotel.  
KPO, San Francisco, Calif. (Pacific, 423), 8-12 midnight, Art Weidner's dance orchestra; tango lesson, Ethel Suhl.  
KSD, St. Louis, Mo. (Central, 546), 4 p. m., hour for the housewife; 8:30, program, Exchange club.  
KYW, Chicago, Ill. (Central, 336), 6:35-7 p. m., children's bedtime story, Uncle Bob; 7-7:30, dinner concert, Congress hotel; 8-8:58, Ballentine Ladies' quartet; Marion Crawford, pianist; Indiana Male quartet; 9:05, Youth's Companion; 9:35-11:30, late show, Congress hotel studio; 12-2, show, Congress hotel studio, Con-Sanders Original Nighthawks.  
WAAW, Omaha, Neb. (Central, 286), 11-4 a. m., special midnight frolic, Fred Hughes, Bill Axtman; concertina orchestra of South Omaha.  
WBAV, Columbus, Ohio (Eastern, 423), 9 p. m., dance orchestra, Spring Lakes pavilion.  
WBBR, New York, N. Y. (Eastern, 273), 8 p. m., Hazel Jantzen, violinist; 8:15, Bible questions and answers, Judge Rutherford; 8:40, Hazel Jantzen.  
WBZ, Springfield, Mass. (Eastern, 337), 6 p. m., Leo Reisman Hotel Lenox ensemble; 6:30, Copley Plaza orchestra, W. Edward Boyle, director; 7:05, bedtime story for the kiddies; 7:30, concert, Hotel Kimball trio; 8, program, Mme. Duchesne, director; Helen Norwood, soprano; Charles Kallmann, baritone; 9, program, members, Durant Inc., Women's Health and Recreation organization; talk, Florence Baker Child; 10, concert, Mme. Eugenie Tessier Sirols; Mrs. Josephine Proulx Sizer; Mrs. Albertine Gagnon Dean, soprano; Ernestine Alexandre, pianist; Bernadette Bourbonnais, accompanist; 11:30, Leo Reisman and his Hotel Brunswick orchestra.  
WCAE, Pittsburgh, Pa. (Eastern, 462), 6:30 p. m., dinner concert, Ed Lally and his Rendezvous Cabaret

and her syncopators; 9-9:45, dance music, Waldorf-Astoria hotel, Joseph Knecht, director; 9:45-11, dinner, St. Nicholas Society Prom, Hotel Baltimore; 11-12, p. m., Alamac orchestra; 7:30-8, Hotel Carlton Vincent Lopez and his Hotel Pennsylvania orchestra.  
WEBB, Chicago, Ill. (Central, 370), 7-8 p. m., Oriole orchestra concert; Radio Sunday school lesson, Dr. Herbert W. Virgin; Jean Davenport, contralto; 9-10, Oriole orchestra; yellow, red and orange tales, William H. Hunt; Langdon brothers, Hawaiian guitarists; Marie Kelly, reader; 11-12, Oriole orchestra; Langdon brothers, Hawaiian guitarists; Marie Kelly, reader; Dennis sisters, songs.  
WFAA, Dallas, Tex. (Central, 476), 8:30-9:30 p. m., Dr. Richard Mandell, tenor; 11-12, dance music, Adelphus hotel orchestra.  
WFI, Philadelphia, Pa. (Eastern, 395), 6:30 p. m., Meyer Davis Bellevue Stratford concert orchestra; 7, Sunny Jim, the kiddies' pal; 8, "Lye and Its Dangers" talk, auspices Philadelphia County Medical society; 8:15, concert, Kelly Street Business Men's association; chorus, direction C. Albert Hartmann; 9:15, talk, Samuel S. Fleisher.  
WGBS, New York, N. Y. (Eastern, 316), 6:30-7:30 p. m., Cameo Collegians, Dick Shipley, leader; 7:30-8:30, Armand Vecey and his Ritz-Carlton orchestra; 8:30-9:30, first weekly hour, New York Herald-Tribune; 9:30-9:45, Sam Comly's movie chats; 9:45-10:15, musical program; 10:15-11, Josiah B. Free, baritone; 11-12, Russian Eagle orchestra.  
WGN, Chicago, Ill. (Central, 370), 8:30-9 p. m., classical program; 10-11, dance program, Drake and Blackstone dance orchestra.  
WGR, Buffalo, N. Y. (Eastern, 319), 6-7:30 p. m., Hallpyrd string quartet.  
WGY, Schenectady, N. Y. (Eastern, 380), 9:30 p. m., dance music, Phil Romano's orchestra.  
WHAS, Louisville, Ky. (Central, 400), 7:30-9 p. m., concert, auspices Arthur Flooding.  
WHK, Cleveland, Ohio (Eastern, 283), 6 p. m., Ponce de Leon orchestra, Herbert Hayward, director; Greer's Hanna Building restaurant; 8 p. m., Rainbow club entertainers; Billie Bugbee, Luellie Phillips, Betty Booth, Alice Crandall, Violet Owens, June Farley, Bobbie and Dede Fitzpatrick, Ethel Rohde, George

organist; Harmony girls; Isham Jones and his College Inn orchestra.  
WMC, Memphis, Tenn. (Central, 500), 8 p. m., bedtime story, Uncle Percy; 8:30, classical program, Walter Moore.  
WMH, Cincinnati (Central, 309), 10 p. m., piano solos and duets, Laura and Carrie Dotzauer; songs, Bernard and Robinson; organ selections, Carrie Dotzauer; 11, Hotel Alms orchestra; contralto solos, Marie Turner; piano solos, Lella Lemar; tenor solos, Howard Hafford.  
WOAW, Omaha, Neb. (Central, 526), 6 p. m., popular half-hour; 6:30, dinner program; 9, program transmitted from WOAW's studio in the May Seed & Nursery company building, Shenandoah, Iowa; 11:15, Wow! frolic, Frank Hodek, Jr., and his Omaha Nightingales.  
WOC, Davenport, Ia. (Central, 484), 7 p. m., sandman's visit; 7:30, discussion, international Sunday school lesson, Rev. M. A. Getzendauer, pastor; 9, Louie Connor and his LeClaire hotel roof garden orchestra.  
WOR, Newark, N. J. (Eastern, 405), 6:15-7:15 p. m., "Musie While You Dine," Wm. C. Young Harmonians; 7:15-7:30, resume of the day's sports, Jolly Bill Steinke; 8:45-9, Freda Pasta, piano recital; 9-9:20, Criterion male quartet; 9:20-9:45, Dr. Vizzetelli talking on good English; 9:45-10, Freda Pasta; 10:15-10:30, Criterion male quartet; 10:30-11, Manhattan Serenaders.  
WQI, Chicago, Ill. (Central, 448), 7-8 p. m., dinner concert, Ralph Williams and his Rainbo Garden orchestra; Henrietta Nolan, violinist; Otis Pike Jester, soprano; Mary Thrash House, pianist; 10-2, Ralph Williams and his Rainbo Skylarks; The Brock Sisters; Jerry Sullivan; The Melodians, Laurie, Eddie, Bennie; Lindsey Coors, baritone; Lew Butler, giant of Radio.  
WRC, Washington, D. C. (Eastern, 469), 7 p. m., children's stories, Peggy Albion; 7:15, dinner concert, Irving Boernstein's Washington hotel orchestra; 8:15, Bible talk; 8:30, Marie C. Deal, soprano; music; 10:30, dance program, Hotel Astor orchestra; 11:15, Otto Beck, organist.  
WSAI, Cincinnati, Ohio (Central, 309), 8 p. m., chimes concert; 8:15, Bicycle male quartet; piano solos, Genevieve Goodman; 9, weekly news review, Allison F. Stanley; 9:15, male voice quartet; 12, WSAI midnight entertainers; Freda Sanker's orchestra.  
WSB, Atlanta, Ga. (Central, 429), 5-6 p. m., bedtime story, Bonnie Barnhardt; 8-9, week-end revue; 10:45, Journal Hired Help Skylark.  
WTAM, Cleveland, Ohio (Eastern, 390), 3 a. m., special program for Pacific coast; Eddie Peabody, banjoist; Guy Lombardo's Royal Canadians orchestra; vocal soloists; 6 p. m., Guy Lombardo's Royal Canadians orchestra; 8, WTAM dance orchestra, Ev Jones, director.  
WTAS, Elgin, Ill. (Central, 286), 6-8 p. m., dinner hour program, Tip Top Inn; WTAS artists.  
WTAY, Oak Park, Ill. (Central, 283), 6:45-7:45 p. m., Ardith Irene James, pianist; Dr. W. F. Zimmer, tenor; Andy Wendell, violinist; 9-9:45, 10:15-11:15, Guyon's Paradise orchestra.

(Continued on page 12)



# WCAP TO BROADCAST LAST FOOTBALL

## Where to Hear Concerts

Central Standard Time

THESE are the stations for music lovers to dial, and you can hear, providing you dial correctly and read the programs carefully, everything from jazz to opera.

**Saturday, December 6th: 6, WGN; 6:15, WRC; 6:20, WEEI; 6:30, CKAC, WGN; 6:45, WTAY; 7, KYW, WBBR; WCAU, WLS, WQJ; 7:15, WFL, WLS; 7:30, CKAC, KFNF, WBZ, WHAS, WJZ, WRC; 7:45, WCAE, WOR; 8, KNX, KYW, WMAQ, WOR, WSAI, WSB; 8:30, KSD, WFAA, WGN, WMAQ, WMC; 8:45, WOR; 9, WMAQ, WOC; 9:15, WOR, WSAI; 9:35, KYW; 10, KFI, KGO, KHJ, KNX, WMH, WQJ; 10:05, WIP; 10:15, WRC; 10:30, KFNF; 10:45, WSB; 11, KFI, WMH, WAAW; 12, KFI, WCAI.**

**Sunday, December 7th: 6, WCAU; 6:20, WEA; 6:30, KFNF, WLS; 7, KYW, WLS; 7:30, WHO, WOS; 8, WGY, WHK, WQJ; 8:10, WBBR; 8:15, KFGZ, WEA; 8:30, WCAI, WIP; 8:45, WLW; 9, KFI, KGW, KHJ, WFAA, WGN, WHAA, WOA; 9:30, WFAA, WOC; 10, KFI, KGO, KHJ, KJS, KNX; 10:30, KPO; 11, KFI, KNX; 12, KFSG, KNX.**

**Monday, December 8th: 6, WEA, WGN, WIP; 6:30, KOB, WGN, WOO; 6:45, WGY; 7, WBBR, WBZ, WCAE, WCAU, WEA, WTAM; 7:15, WJJD; 7:30, CHNC, WCX, WHO, WOR; 7:45, WHA; 8, WCAE, WCB, WDAF, WHAZ, WHO, WLW, WMH, WOC, WOS; 8:15, KFGZ; 8:30, WCAE, WEEI, WFAA, WMC; 9, KFGZ, WEEI, WMH, WOA; 9:03, WOO; 9:30, KFAC, KFAC, WMC; 10, KGO, KGW, KNX, KPO, WOC, WSAI; 11, KFI, KPO; 11:15, WHO; 12:30, WKAQ.**

**Tuesday, December 9th: 6, KGO; 6:30, WEEI, WJAX, WLS, WOA; 6:45, WCAE, WTAY; 7, WBBR, WBZ, WFL, WQJ; 7:15, CKY, WJJD; 7:30, CKAC, KFNF, WBZ, WCAE, WEA, WEEI, WHAS, WLS, WSAI; 8, KNX, WCAE, WEA, WHB, WIP; 8:20,**

**WRC; 8:30, KHJ, WFAA, WMC, WOS; 8:45, KFI; 9, KFKE, WEA, WLS, WOA, WSAI; 9:15, WCAE; 9:30, WCAE; 9:45, WOA; 10, KFI, KGO, KHJ, KJS, KPO, WLW, WQJ; 10:15, WLF; 10:30, KGW, WBZ; 10:40, WLS; 11, KFI, KPO, WFAA, WLS, WMC; 12, KFI.**

**Wednesday, December 10th: 6, KGO; 6:30, WCAE, WEA, WOO; 6:45, WCAE, WOA, WTAY; 7, WCAU, WBAO, WEEI, WTAM; 7:15, WJJD; 7:30, KFNF, WBZ, WCAE, WCX, WHAS, WOR; 7:45, WHA; 8, KFDM, WDAF, WOC, WOO; 8:10, WBBR; 8:30, WOR; 8:40, WLW; 9, KNX, KPO, WBBR, WOA, WOR; 9:03, WOO; 9:30, KFAC, KFI, KHJ, KFAC; 10, KFI, KGW, KNX, KPO, WEEI, WKAQ, WOR; 11, KFI, KHJ; 12, KFI.**

**Thursday, December 11th: 6, KGO; 6:15, WRC; 6:30, KOB, WEEI; 6:45, WCAE, WEA; 7, CNRW, WDBY, WFI, WGY, WHK, WQJ; 7:15, WIP; 7:30, CNRM, KFNF, WBZ, WCAE, WBAO, WHAS; 8, WCB, WEA, WHB, WMH; 8:15, WRC; 8:30, WCX, WEA; 9, WCAI, WOC; 9:30, KFI, WEA, WMC; 10, KGO, KFI, KHJ, KJS, KPO, WQJ, WSAI; 10:30, WCAE, WLW; 10:45, WSAI; 11, KFI, KPO, WLW; 11:15, KFSG, WLW; 12, KFI.**

**Friday, December 12th: 6:30, WOA, WOO; 6:45, WEA; 7, WCAE, WCAU, WEA, WGY, WHK, WQJ; 7:15, CKY, WCAE; 7:25, WOO; 7:30, CNRT, KFNF, WBZ, WCAE, WHAS, WHO; 7:45, WHA; 8, WCAE, WEA; 8:30, WFAA, WHO, WMC; 9, WBZ, WEA, WGY, WOA; 9:03, WOO; 9:30, KFAC; 10, KHJ, KNX, WQJ; 10:30, WKAQ; 11, KNX, WMC; 11:15, KFSG; 11:30, KHJ; 12, KFSG.**



Harold Anson Bruce (above), the director of physical training and athletics at Union College, gives the weekly sport talk Monday at WGY, Schenectady.

Ira Hamilton, pianist; Oscar Williamson, tenor; Harry Abernethy, accompanist; Marjorie Borssen, baritone; Fern Denicke, accompanist; George Chovance, tenor. WSAI, Cincinnati, Ohio (Central, 309), 8 p. m., sermonette; 8:15, sacred chimes concert. WTA, Elgin, Ill. (Central, 286), 8-8 p. m., Tip Top Inn string sextet; 8-12, Terrace Garden dance program; Bert Davis, Lee Sims, Florence Sanger. WWJ, Detroit, Mich. (Eastern, 517), 2 p. m., The Detroit News orchestra.

Dorothy Lewis, whose mezzo-contralto voice is always applauded by the fans of KGW, Portland, will sing for them again Sunday, December 14.

### Monday, December 8

Monday, silent night for: CKAC, CKY, KFDM, KFNF, KFSG, KHJ, KJS, KYW, WDBY, WEA, WEEI, WGN, WHAS, WJAX, WKAQ, WMAQ, WNI, WQJ, WRC, WTAY.

**CHNC, Toronto, Can. (Eastern, 350), 8:30 p. m., string quartet, Frank Blachford, violinist; Albert, Aylward, violinist; L. H. Bliton, cellist; Earl Meisner, violist; A. Weir, contralto; Grace Harrison, pianist; Ruth Robertson, soprano; Simeon Joyce, pianist.**

**KFAE, Pullman, Wash. (Pacific, 330), 7:30 p. m., violin quartet, Doris McKeon, Margaret MacLachlan, Gladys Fraser, Evelyn Sparlin; "Important Points in Poultry Raising," J. S. Carver; "Present Tendencies in Auto Design," A. C. Abell; "1924 Accomplishment in Agriculture," W. W. Underwood.**

**KFGZ, Berrien Springs, Mich. (Central, 270), 7 p. m., bedtime story; 8:15-8:30, Lighthouse saxophone sextet; 8:30-8:40, Mary Lou Luckock, soprano; 8:40-8:50, Tom Johnson, tenor; 8:50-9, Mrs. H. B. Taylor, soprano; 9-9:15, Mrs. Bert Summers, pianist.**

**KFI, Los Angeles, Calif. (Pacific, 469), 8-9 p. m., The Nightingales, dance orchestra, Virginia Hoffman, contralto; 9-10, Examiner; community program; 10-11, dance orchestra.**

**KFKB, Milford, Kansas (Central, 286), 10-11 p. m., lecture, Dr. Osborn; 11-12, Dr. Brinkley.**

**KFKX, Hastings, Neb. (Central, 291), 9:30-11 p. m., vocal numbers, Mrs. Stryker; piano accordion solos, Haley Campbell.**

**KFGZ, Oakland, Calif. (Pacific, 312), 8 p. m., Arion trio; "Soll Management," Prof. C. F. Shaw; "A Lesson in English," Wilda Wilson Church; "Chats About Books," Joseph Henry Jackson; 10-11 a. m., Henry Halstead's orchestra.**

**KGW, Portland, Ore. (Pacific, 492), 8 p. m., concert, Oregonian concert orchestra; 10, dance music, George Olsen's Metropolitan orchestra.**

**KHJ, Los Angeles, Calif. (Pacific, 395), 12:30-1:30 p. m., Orpheus four, Mackie's Queens Hawaiians; 1 p. m., string quartet; (Pacific, 337), 8-10 p. m., feature program, Western Auto Supply company; 10-11, Lindsay's dance orchestra; 11-12, Abe Lyman's Coconut Grove dance orchestra.**

**KOB, State College, N. M. (Mountain, 360), 7:30-8:30 p. m., musical program.**

**KPO, San Francisco, Cal. (Pacific, 423), 7-7:30 p. m., Rudy Seiger's Palmont hotel orchestra; 8-9, organ recital, Theodore J. Irwin; 9-10, vocal and instrumental program; Annette Jans, lyric soprano; 10-11, E. Max Bradford's versatile band.**

**WAAW, Omaha, Neb. (Central, 286), 7:30-9 p. m., The Omaha Nite Ramblers.**

**WBBR, New York, N. Y. (Eastern, 273), 8 p. m., 1 p. m., string quartet; 8:15, Carl Park, violinist; 8:25, world news, editor of the Golden Age; 8:45, Carl Park, violinist; 8:50, I. B. S. A. quartet.**

**WBZ, Springfield, Mass. (Eastern, 337), 6-7 p. m., dinner concert; 7:10, kiddies bedtime stories; 7:15-7:30, lectures and addresses; 8-10:30, concert; 11:30-12, McEnelly's singing orchestra.**

**WCAE, Pittsburgh, Pa. (Eastern, 462), 6:30 p. m., dinner concert, William Penn hotel; 7:30, Uncle Knave; 7:45, weekly music chat, Mrs. Davis; 8, program, Nixon restaurant; 9:30, concert, artist-pupils, studios, Mme. Lella Wilson-Smith; 11, flight, Mythical Dirigible, The Press-Kaybee and concert, Billy Craver's orchestra.**

**WDAF, Philadelphia, Pa. (Eastern, 278), 6 p. m., Meyer Davy, host; Pennsylvania dance orchestra, direction Louis Bieri; 8, talks and recitals.**

**WCB, Zen, Ill. (Central, 345), 8 p. m., Brass quartet; Fred Faassen, organist; vocal trio, Sweeney, Naffziger, Crowe; vocal duet, DePew, Donovan; Ruth Pihl, soprano; Arthur Rendall, clarinetist; Lois Wiedman, reader; Mrs. David McElroy, pianist.**

**WCO, Minneapolis-St. Paul, Minn. (Central, 417), 6 p. m., sport hour; 8, lecture hour; 8:30, concert; 9:30, Geo. Osborn's Original Nicolett Hotel orchestra; Bill Axtman and Fred Hughes, entertainers.**

**WCEE, Elgin, Ill. (Central, 286), 6-8 p. m., Tip Top Inn string sextet, Walter Blaufuss, director; Fred Hamm's Terrace Garden orchestra; 8-12, Villa Star Monday night radio concert; WTAS orchestra; Jimp Egert, Ziegler Sisters, Jimmy Cairns, Lindsey Coons, Jack Perry.**

**WCX, Detroit, Mich. (Eastern, 517), 6 p. m., dinner concert; 8:30, musical program.**

**WDAF, Kansas City, Mo. (Central, 411), 6-7 p. m., school of the art, piano tuning in number on the "Duo-school" of personal message from Roger W. Babson, statistical expert; the Tell-Me-a-Story Lady; music, Hotel Muehlobach Trianon ensemble; 8-9:15, program, Ivan**

hoe band, Walter A. French, director; Ivanhoe Glee club, Edward H. Gill, Jr., director; 11:45-1 a. m., nighthawk frolic, the "Merxy Old Chief" and the Plantation players.

**WDAR, Philadelphia, Pa. (395), 7:30 p. m., Dream Daddy's bedtime stories; 7:45, Short Agro-Waves, talk; 8, Stanley theater, symphony orchestra, Sidney Lwenstein, director; 10:05, Arcadia cafe dance orchestra; vaudeville features from Fay's theater.**

**WEAF, New York, N. Y. (Eastern, 492), 6-7 p. m., dinner music, Waldorf-Astoria hotel; 7-7:20, Harriet Youngs, soprano; 7:20-7:40, Rafael Samuelli and Maria Samuelli, piano duets; 8-8:15, Mears and company; 8:30-9, The Three Peasants; 9-10, A and P Gypsies; 10-11, Bud Fisher's Happy Players.**

**WEEI, Boston, Mass. (Eastern, 303), 6 p. m., dance selections, Jack Renard and his Mansion Inn orchestra; 7, Boston Edison Big Brother club; 7:30, "A Few Minutes with Santa Claus," Houghton & Dutton company; 7:45, concert, W. L. Sargeant, director; 8:45, Buddy's Bostonians; 10, "The Mesh," Geoffrey L. Whalen players.**

**WFAA, Dallas, Tex. (Central, 476), 8:30-9:30 p. m., Mozart choral club, Earle D. Behrends, director.**

**WFI, Philadelphia, Pa. (Eastern, 395), 6:30 p. m., Meyer Davis Bellevue Stratford concert orchestra; 7, Sunny Jim the kiddies' pal.**

**WGB, Buffalo, N. Y. (Eastern, 319), 6:30-7:30 p. m., Vincent Lopez Hotel Statler dance orchestra, Harold F. Gleser, director; 9-9:30, Pilgrim male quartet; 9:30-11, concert program by Kurtzman Piano company; 11:30, supper-dance music, Vincent Lopez Hotel Statler dance orchestra, Harold Gleser, director.**

**WGY, Schenectady, N. Y. (Eastern, 300), 7:35 p. m., "What Future Has the Farm to Offer to Boys," Jared Van Wageningen, Jr.; 7:45, Aeolian Saxophone quartet; Walter L. Brooks, pianist; Berthold Reymann, saxophonist; Willard J. Van Wormer, Jr., tenor.**

**WHA, Madison, Wis. (Central, 360), 7:45 p. m., music, University School of Music; speech contests, Prof. B. W. West, director.**

**WHAZ, Troy, N. Y. (Eastern, 380), 9 p. m., Elks' night, auspices, Troy Lodge, No. 141, B. P. O. E.; 12, transcontinental and international program, Campus serenaders.**

**WHB, Kansas City, Mo. (Central, 411), 7-8 p. m., The Automotive Battery, A. G. Evans, address, Mrs. Bonnie L. Taylor; music, Sweeney Radio trio.**

**WHK, Cleveland, Ohio (Eastern, 283), 6 p. m., Ponce de Leon orchestra, Herbert Hayward, director, Grebe's Hanna Building restaurant; 7 p. m., Ethel O. Hawes, bedtime story.**

**WHN, New York, N. Y. (Eastern, 360), 6:30-7:10 p. m., Almac orchestra; 7-10:30, fashion chats, Mme. Belle; 7:30-8, Hotel Carlton Terrace orchestra; 8-8:30, Roseland dance orchestra; 8:50-9:20, Littmann's Employees orchestra; 9:30-10, Crystal Palace orchestra; 10-11, Radio Shack orchestra; 12-12:30, Wigwam club orchestra.**

**WHO, Des Moines, Ia. (Central, 526), 7:30-9 p. m., Lowell Smith, trombone soloist; Herman A. Brethaupt, zither soloist; classical program, Holmes Cooper, director; 11-12, L. Carlos Meier, organist.**

**WIP, Philadelphia, Pa. (Eastern, 509), 6:05 p. m., St. James hotel dinner dance orchestra; 7, Uncle Wip's bedtime stories; songs, Evelyn Leaf.**

**WJJD, Mooseheart, Ill. (Central, 278), 7:15-8:15 p. m., Philharmonic orchestra; talk on activities, Ben Oswalt.**

**WLW, Cincinnati, Ohio (Central, 423), 8 p. m., Santa Claus hour, featuring violin duets by Charles and Andrew Jacobs, accompanied by their mother; 8, Methodist Book Concern chorus singing "Song of the Vikings"; "Lady Bird"; 8:10, Miami University orchestra; weekly theatrical review; 8:55, Copper orchestra, playing march; 9:16, the Field Artillery; "The Bohemian Girl"; "The shadow of the shamrock"; "My Old Kentucky Home"; "The Blue Danube"; "Just Like the Dawn"; "Rolling Thunder."**

**WMC, Memphis, Tenn. (Central, 500), 8 p. m., bedtime story, Uncle Joe; 8:30, concert, Georgia serenaders, Hotel Gayoso; 9:30, Addy Britt and Dick Finch.**

**WMH, Cincinnati, Ohio (Central, 309), 8 p. m., piano solos, Ed Schochler; songs, Wright and Bissinger; 9, organ recital; 9:30, Blue Grass Entertainers.**

**WOAW, Omaha, Neb. (Central, 526), 6 p. m., dramatic hour, Davis Studio of Expression; 6:30 dinner program, Sammy Heiman's orchestra of Bramble Store restaur-**

### DANCING (Central Time)

**Saturday, Decemb**  
6, Wjz; 7, Weaf; 7:30, Weac; 8, Khj; 8:45, Wrc; 9:30, Wfl; 10, Wgn; 11:45, Wbb; 12, Kfgz.

**Monday, Decemb**  
6, Wjz; 7, Weaf; 7:30, Weac; 8, Khj; 8:45, Wrc; 9:30, Wfl; 10, Wgn; 11:45, Wbb; 12, Kfgz.

**Tuesday, Decemb**  
6, Wjz; 7, Weaf; 7:30, Weac; 8, Khj; 8:45, Wrc; 9:30, Wfl; 10, Wgn; 11:45, Wbb; 12, Kfgz.

**Wednesday, Decemb**  
6, Wjz; 7, Weaf; 7:30, Weac; 8, Khj; 8:45, Wrc; 9:30, Wfl; 10, Wgn; 11:45, Wbb; 12, Kfgz.

**Thursday, Decemb**  
6, Wjz; 7, Weaf; 7:30, Weac; 8, Khj; 8:45, Wrc; 9:30, Wfl; 10, Wgn; 11:45, Wbb; 12, Kfgz.

**Friday, Decemb**  
6, Wjz; 7, Weaf; 7:30, Weac; 8, Khj; 8:45, Wrc; 9:30, Wfl; 10, Wgn; 11:45, Wbb; 12, Kfgz.

### Sunday, December 7

(Continued from page 11)

Sunday, silent night for: CHNC, CKAC, KFAC, KFDM, KFGZ, KOB, WAAW, WDAF, WDAR, WEA, WHA, WJAX, WJJD, WKAQ, WLS, WNI, WOR, WRC, WSAI, WTAM, WTAY, WWJ.

**CKY, Winnipeg, Can. (Central, 450), 7 p. m., services, St. James Anglican church.**

**KFGZ, Berrien Springs, Mich. (Central, 270), 10:15-10:30 a. m., sacred songs, Lighthouse choir; 10:30-10:40, Catherine Borgon, violinist; Rena Eby, flutist; 10:40-11:15, studio chapel services, Pastor W. R. French; 7 p. m., bedtime story; 8:15-8:30, sacred music, Radio Lighthouse choir; 8:30-8:50, sermon, Pastor John Knox; 8:50-9:15, Mrs. A. Fellows, contralto; Ernest Hurd, tenor.**

**KFI, Los Angeles, Calif. (Pacific, 469), 4-5 p. m., vesper service; 6:45-7, musical appreciation talk; 7-8, stage acts, specialties, orchestra from Metropolitan theater; 8-9, several one-act plays; 9-10, Examiner; Radio wedding and movie stars; 10-11, Lake Arrowhead dance orchestra.**

**KFNF, Shenandoah, Ia. (Central, 266), 3 p. m., sacred concert, Tingley, Ia.; 6:30, regular sacred song service.**

**KFGS, Los Angeles, Calif. (Pacific, 278), 10:30-12:30 p. m., complete religious services, Angelus temple, Aimee Semple McPherson, pastor; 2:30-4:30, afternoon church services; silver band and choir; 7-9:45, complete evening services, Angelus temple, Esther Erick Green, organist; 10-11, organ recital, Roy Reid Brignall.**

**KGO, Oakland, Calif. (Pacific, 312), 3:30 p. m., KGO Little Symphony orchestra; 8, special musical service, St. Luke's Episcopal church, Rev. W. W. Jennings, rector.**

**KGW, Portland, Ore. (Pacific, 492), 3 p. m., municipal concert; 6, church service, Portland Council of churches; 7, dinner concert, Colburn Concert orchestra; Louise Jacobs, pianist.**

**KHJ, Los Angeles, Calif. (Pacific, 395), 10 a. m., sermon, Rev. Gordon Palmer; 10:30-12:30 p. m., organ recital and religious service, First Methodist Episcopal church; 6:30-7, Art Hickman's concert orchestra, Edward Fitzpatrick, director; 7-7:30, organ recital, Arthur Blakely; 8-10, program, Mullen and Bluet.**

**KJS, Los Angeles, Calif. (Pacific, 360), 10:45-12:30 p. m., complete morning church services, Church of the Open Door; 6-6:45, vesper service, classical vocal numbers; 8-9:30, evening services, choir, organ and vocalists.**

**KNX, Hollywood, Calif. (Pacific, 337), 7 p. m., W. Scott Lewis and Town Crier, program for boys and girls on outdoor life; 8-9, Ambassador hotel concert orchestra, Jose Rosenfeld, director; 9-10, feature program; 10, June Purcell, "Queen of the Blues."**

**KPO, San Francisco, Cal. (Pacific, 423), 8:30-10 p. m., concert, Rudy Seiger's Fairmont hotel orchestra.**

**KYW, Chicago, Ill. (Central, 536), 7 p. m., Chicago Sunday Evening club; "The Spiritual Basis of Life," Prof. S. Angus.**

**WBVA, Columbus, Ohio (Eastern, 423), 2:30 p. m., religious service, Columbus Council of churches; choir music and sermon.**

**WBBR, New York, N. Y. (Eastern, 273), 9-10 p. m., 1 p. m., S. A. Choral singers; 9:20, vocal solos; 9:25, Bible lecture, Judge Kutherford; 9:50, vocal solos, 10, L. B. S. A. Choral singers.**

**WBZ, Springfield, Mass. (Eastern, 337), 8:30-10 p. m., concert.**

**WCAE, Pittsburgh, Pa. (Eastern, 462), 3 p. m., People's Radio church; 6:30, dinner concert, William Penn hotel.**

**WCAI, Northfield, Minn. (Central, 360), 8:30 p. m., sacred program, Rev. Nils Kleven, pastor; Nona Cav, pianist, contralto; Obed Grinder, tenor.**

**WCAU, Philadelphia, Pa. (Eastern, 278), 5:30 p. m., Bible talk; 6, dinner music, Meyer Davis Hotel Pennsylvania orchestra, direction Louis Baer.**

**WCCO, Minneapolis-St. Paul, Minn. (Central, 417), 7:30 p. m., House of Hope Presbyterian church service; 7:30 p. m., service; 9:15 p. m., musical concert.**

**WCX, Detroit, Mich. (Eastern, 517), 6 p. m., dinner concert; 7:15, services of the Central Methodist Episcopal church.**



# BALL GAME SATURDAY—ARMY, MARINES



Lee Lawnhurst is one of the new attractions of Roxy's gang at the Capitol theater, WPAE, New York.

## Where to Hear Talks

Central Standard Time

TALKS, instructive, serious, humorous and even frivolous, are Radiocast daily and below are listed the stations.

- Saturday, December 6th:** 6, WDAF; 6:15, WBZ; 6:30, WEAF; 6:35, KYW; 7, KFI, WFL, WIP, WJZ; 8, WMC; 8:15, WFI; 8:20, WOR; 8:30, KHJ; 8:40, WMAQ; 9:05, KYW; 9:30, KHJ; 9:45, KFI.
- Sunday, December 7th:** 6, WFAA; 7:20, WOC; 8, KJS; 8:30, KFGZ; 8:45, KFI; 9, KNX.
- Monday, December 8th:** 6, WDAF, WFL, WHK, WLW; 6:15, WGY; 6:30, WBZ, WEEI; 6:45, WCAE, WDAE; 7, WBBZ, WCAU, WBB, WOR; 7:20, WEAF; 7:45, WHA; 8, WMC; 10, KFKB, KGO; 11, KFKB.
- Tuesday, December 9th:** 6, WDAF, WFL, WHK, WLW; 6:15, WBZ, 6:30, KY, 6:50, WDAE; 7, WEEI, WIP, WRC; 7:30, WRC; 7:45, WOR; 8, WLS, WMC, WRC; 8:30, KFSG; 9:05, WIP.
- Wednesday, December 10th:** 6, WDAF, WFL, WLW; 6:15, WBZ; 6:30, KOB; 6:40, WEEI; 7, WDAE, WBB; 7:30, WDAE; 7:45, WHA; 8, WHA; 8:30, KFSG; 8:45, KFI; 9, WMH; 10, KFKB; 11, KFKB.
- Thursday, December 11th:** 6, WDAF, WFL, WLW; 6:15, WBZ; 6:30, CKY; 7, WEAQ; 7:15, WRC; 7:30, WAAW, WEAF; 7:45, WRC; 8, WAAW, WIP, WMC; 8:30, KHJ; 8:45, KFI; 9:30, KHJ; 9:45, KNX; 10, KFKB, WSAI; 11, KFKB.
- Friday, December 12th:** 6, WDAF, WFL, WHK; 6:15, WBZ; 6:30, CKY, WEAF, WEEI; 6:45, WGY; 7, WHB; 7:20, WOC; 7:30, KGO, WEAF; 8, WMC; 8:30, KHJ, WCAL; 9:30, KFSG; 10, KGW.

- Shoo," "A June Morning," and "Oh That We Two Were Maying," Harry W. Hanlon, tenor, singing "Dear Land of Home," 9-9:45, popular music, Gilbert Jaffy's orchestra.
- WHK, Cleveland, Ohio (Eastern, 283), 6 p. m.,** Ponce de Leon orchestra, Herbert Hayward, director, Grebe's Hanna Building restaurant; sports, news.
- WHN, New York, N. Y. (Eastern, 360), 6:30-7 p. m.,** Alama orchestra; 7-7:10, E. S. Collins, movie; 7:10-7:30, WBB, film; 7:30-7:45, broadcast; 9:30-10, Bertini; J. Goodman orchestra; 10-10:30, Cinderella orchestra; 11:30-12, Club Alabam orchestra; 12:30-1 a. m., Club Madrid orchestra.
- WIP, Philadelphia, Pa. (Eastern, 509), 6:05 p. m.,** Harvey Marburger and his vaudeville orchestra, featuring Roy Reuber, recording pianist; 7, Uncle Wip's bedtime stories; 8, "The Theater," Elliott Lester, dramatic critic; 8:15, Stephen J. Benn's instrumental quartet, Walter Dreher, cellist; Charles Weinberger, flutist; Ed. Harsch, pianist; Walter Benn; 9, concert by Philadelphia Police band, Lieut. Joseph Kiefer, conductor; 10:05, "Behind the Screen with Screen Folk," E. M. Orowitz; 10:30, Harvey Marburger's vaudeville dance orchestra.
- WJAX, Cleveland, Ohio (Eastern, 300), 7:30 p. m.,** program arranged by the Cleveland News-Leader; E. G. Johnson, bedtime story; Don Palmer, Radio talk cartoon; Mrs. Evelyn Phillips, soprano; Mrs. Austin, contralto; Mrs. Helen R. Douglas, pianist; Opal S. Hemler, soprano; Bertha McLaughlin, contralto; mixed quartet and solos; Joe Smith-Martha Lee Club orchestra.
- WJJD, Mooseheart, Ill. (Central, 278), 7:15-8:15 p. m.,** concert band; talk, Adams.
- WLS, Chicago, Ill. (Central, 345), 6:30 p. m.,** Ralph Emerson, organist; 7, lullaby, Glenn Rowell, Ford Rye; 7:15, visiting talent; 7:30, Sadler's features; 7:45, visiting talent; 8-9, "Better Milk for Boys and Girls," E. T. Sadler; 9, WLS theater; 10, Isham Jones and his College Inn orchestra; 10:15, music; 10:40, Ford and Glenn time; 11, music numbers; 12, midnite revue, Ralph Emerson, organist; Isham Jones and his College Inn orchestra; Ford and Glenn.
- WLX, Cincinnati, Ohio (Central, 423), 6 p. m.,** Santa Hughes, tenor; 6:15, resume of the day's sports; instrumental trio; 11, Kibler's orchestra; songs, Mrs. V. B. Gulberg.
- WMC, Memphis, Tenn. (Central, 500), 8 p. m.,** bedtime story, Uncle Jerry; 8:30, Drama League play sponsored by Sarah Wright; 11, midnight frolic, Addy Britt and Dick Finch.
- WNR, Frank Daily and his Meadowbrook orchestra.**
- WOAW, Omaha, Neb. (Central, 526), 6 p. m.,** "Advice to Lovelorn" period conducted by Cynthia Grey, editor of "Please Tell Me" of the Omaha Daily News; 6:25, dinner program, transmitted from WOAW's studio in the May Seed & Nursery company building; Shenandoah, Iowa, 9, program, First Christian church orchestra, Joseph F. Woolery, Jr., director; 9:45, vocal frolic, Walter B. Graham, baritone; 10:30, Wow! frolic, Frank Hodek, Jr. and his Omaha Nightingales.
- WOR, Newark, N. J. (Eastern, 405), 6:15-6:30 p. m.,** "Music While You Dine," Halsey Miller and his orchestra; 6:30-7, man-in-the-moon stories; 7-7:15, "Music While You Dine," Halsey Miller and his orchestra; 7:15-7:30, resume of the day's sports.
- WQJ, Chicago, Ill. (Central, 448), 7-8 p. m.,** dinner concert, Ralph Williams and his Rainbo Garden orchestra; Excelsior quartet; 10-2, Ralph Williams and his Rainbo Skylarks; The Monogram trio, Hibbler, Goldman, Frazee; Harry Gelse; Nubs Allen, contralto; Will Rossiter; Mrs. Blanche Rogers; Boys, Larry, Billy; 10:30-11, "The Merry Old Chief" and the Plantation players.
- WRC, Washington, D. C. (Eastern, 469), 8 p. m.,** "Show Shopping," Len Hall; 8:30, talk, auspices, Federal Board of Vocational education; 9, "The Political Situation in Washington Tonight," Frederic William Wile; 9:20, concert, Irving Boersstein's Wardman Park hotel quartet; 10:15, Meyer Davis' Le Paradis orchestra.
- WSAI, Cincinnati, Ohio (Central, 309), 7 p. m.,** Hotel Gibson orchestra; 7:30, chimes concert; 7:45, bedtime stories, Ethel Knapp Behrman; 8, Gibson orchestra; 9, tenor solos, Carl Cornuelle; reading, "Mrs. Rastus on the Telephone," Ethel K. Behrman; popular songs, Wright and Bessinger.
- WTAM, Cleveland, Ohio (Eastern, 390), 6 p. m.,** Guy Lombardo's Royal Canadian orchestra.
- WTAS, Elgin, Ill. (Central, 286), 6-8 p. m.,** string sextet, Tip Top Inn; Jimmy Eggert, Florence Sanger; 8-12, Fred Hamm and his famous Terrace Garden orchestra.
- WTAY, Oak Park, Ill. (Central, 283), 6:45-7:45 p. m.,** Sandy Meek, baritone; Glenn Bruce; Raynor Dalheim and company orchestra; 9:45, 10-11:15, Harry Sosnik and Ray Crook, pianists; Guyon's Paradise Ballroom orchestra.
- WVJ, Detroit, Mich. (Eastern, 517), 7 p. m.,** The Detroit News orchestra; Jane Robinson, contralto.

## Wednesday, December 10

- Wednesday, silent night for: CHNC, CKAC, CKY, KGO, KJS, WAAW, WCBD, WFAA, WGY, WJAX, WMC, WNJ, WRC, WSAI.
- KFAE, Pullman, Wash. (Pacific, 330), 7:30 p. m.,** Chi Onega National security program; Edna Harpole, violinist; Margaret Zuger, vocalist; Doris Marsalaise, reader; Genevieve Rislis, pianist; "Pointers on Dairy Farming," E. V. Ellington; "Hatching Chicks with a Kick in Them," W. D. Buchanan.
- KFDM, Beaumont, Tex. (Central, 306), 8 p. m.,** musical program.
- KFI, Los Angeles, Calif. (Pacific, 469), 6:45-7:30 p. m.,** Nick Harris, detective stories; 7:30-8, Retta King Nelson, vocal and instrumental program; 8-9, Evening Herald; Kennedy Broadcasters of Long Beach, Herman Abrahamson, saw solos; 9-10, Examiner; glee club; 10-11, John Smallman, vocal recital.
- KFKB, Milford, Kan. (Central, 286), 10-11 p. m.,** lecture, Dr. Geborn, musical; 11-12, Dr. Brinkley.

- Globe Ice company; 10-11, Earl Burnett's Biltmore hotel dance orchestra.
- KJZ, Los Angeles, Calif. (Pacific, 360), 8-9 p. m.,** special vocal and instrumental program of classical nature.
- KNX, Hollywood, Calif. (Pacific, 337), 6-7:30 p. m.,** dinner hour music; 8-8, Lindsay's dance orchestra; 9-10, Paul G. Hoffman's Studebaker orchestra; 10-11, Abe Lyman's Coconut Grove orchestra.
- KPO, San Francisco, Cal. (Pacific, 423), 7-7:30 p. m.,** Rudy Selger's Fairmont hotel orchestra; 8-9, Ailee Goodmurry, soprano; Norma Garrett, mezzo-soprano; Irma H. Vogt, pianist; 9-10, xylophone and marimba music, pupils of Doc Willats-Xylophone school; Bertha Weber, piano solos; Sam Sadowski, violinist; 10-11, E. Max Bradford's versatile band.
- KYW, Chicago, Ill. (Central, 536), 7-7:30 p. m.,** dinner concert, Congress hotel; 7:30-7:45, "Around the Town with KYW in Chicago," 8-8:30, Chicago Musical college; 8:30-8:45, speeches, American Farm Bureau federation; 8:50-9:30, Chicago Musical college; 10-11:30, Evening at Home.
- WBAV, Columbus, Ohio (Eastern, 423), 8 p. m.,** WBAV orchestra, Frances Handibeu, director.
- WBZ, Springfield, Mass. (Eastern, 337), 6-7 p. m.,** dinner concert; 7-10, kiddie's bedtime stories; 7:15-7:30, lectures, addresses; 8:30-10:30, concert; 11:30-12, organ concert.
- WCAE, Pittsburgh, Pa. (Eastern, 462), 6:30 p. m.,** dinner concert, William Penn hotel; 7:30, Uncle Kaybee; 7:45, special feature; 8:30, concert, Three Aces; 9, concert, National Carbon company's Eveready entertainers; 10:30, entertainment, "Sid" and his Loew's Aldine theater gang.
- WCAY, Milwaukee, Wis. (Central, 266), 9:15 p. m.,** Olympians band; Blackstone serenaders, male quartet; one act comedy, "The Nettie," Estelle Fielding, Moran Lutterman; Adeline Skoble, soprano.
- WCD, Minneapolis-St. Paul, Minn. (Central, 417), 6:30 p. m.,** dinner concert, Minneapolis Athletic Club orchestra, C. Eddy Fortier, director; Mattie Peterson, mezzo soprano.
- WCX, Detroit, Mich. (Eastern, 517), 6 p. m.,** dinner concert, Hotel Tuller; 10, The Red Apple club.
- WDAF, Kansas City, Mo. (Central, 411), 6-7 p. m.,** school of the air; piano tuning-in number on the Duo-Art; ninth of a series of radio piano lessons, Madeleine Littlefield; the Tell-Me-a-Story Lady; music, Hotel Muehlebach Trianon ensemble; 11:45-1 a. m., night-hawk frolic, the "Merry Old Chief" and the Plantation players.
- WDAE, Philadelphia, Pa. (Eastern, 395), 7:30 p. m.,** Dream Daddy's bedtime stories; 7:50, "Both Sides of the Footlights," Arnold Abbott.
- WEAF, New York, N. Y. (Eastern, 492), 6-7 p. m.,** dinner music, Waldorf-Astoria hotel; 7:30-8:15, John C. Smith and his Modern dance orchestra; 8:20-8:30, John F. Hill; 8:30-9, Gold Dust Twins; 9-10, National Carbon company; 10-10:30, The Tritone trio; 10:30-11:30, Midnight Sons orchestra.
- WEBB, Chicago, Ill. (Central, 370), 7-8, Orlole orchestra; musical bits, Riviera theater; Harry Davis, baritone; Dennis sisters, songs; 11-12, Orlole orchestra, Nick Luens, soprano; instrumental trio.**
- WEL, New York, N. Y. (Eastern, 273), 7-7:15 p. m.,** Blyburn's review of new photoplays; 7:15-7:30, songs, Jack Healy and Arthur Cant; 7:45-8:15, Judith Roth; Al Wilson, accompanied by Bill Kellner; 8:15-9, dance music.
- WEEI, Boston, Mass. (Eastern, 303), 6:30 p. m.,** Dok-Eisenburg and his Sinfonians; 7, Boston Edison Big Brother club; 7:30, musicale; 8, Radio interview, President Otis Emerson Dunham, Hay Myers; 8:30, musicale; 9-10, program, New York Eveready hour.
- WFAA, Dallas, Tex. (Central, 476), 8:30-9:30 p. m.,** W. Paul Romberg, violinist; Schubert string choir; 11-12, Dwight Brown, organist.
- WFAQ, San Juan, P. R. (Intercolonial, 360), 9-10:30 p. m.,** Eutepie Jazz band, Carmelo Diaz, director.
- WFI, Philadelphia, Pa. (Eastern, 395), 6:30 p. m.,** Meyer Davis Bellevue Stratford concert orchestra; 7, Sunny Jim, the kiddies' pal; 8, concert, Paoli Conservatory of Music; talk, "What is Music?" Emil Knoppel; "Ave Marie" and "Rhapsody in G minor," Clarence Kohman, pianist; Aeolian Harp, Eliza, Beth Traffante, harpist; "Virginia Rose, Angelus," "Erl King" by Madame Duse Sylvia Schoen, soprano; "Reverie, op. 22, No. 3," Bernard Otto, violinist; "The Builder," "Invictus," "Dawn," by William R. Carson, baritone; F. Edna Davis, accompanist.
- WGN, Chicago, Ill. (Central, 370), 6-8:30 p. m.,** Lyon & Healey organ recital; 6:30-7, dinner music, Drake concert ensemble, Blackstone string quintet; 8-9, classic hour; 10-11, Jazz scampers, Jack Chapman's dance orchestra, Don Bestor's orchestra.
- WGR, Buffalo, N. Y. (Eastern, 319), 6-7:30 p. m.,** Halpyrd string quartet; 9-10, "Eveready Hour" from WBAE.
- WGY, Schenectady, N. Y. (Eastern, 380), 6:30 p. m.,** concert ensemble, Blackstone string quintet; 8-9, classic hour; 10-11, Jazz scampers, Jack Chapman's dance orchestra, Don Bestor's orchestra.
- WHAA, Iowa City, Ia. (Central, 484), 8 p. m.,** concert, faculty of school of music.
- WHAS, Louisville, Ky. (Central, 400), 7:30-9 p. m.,** concert, Rosson entertainers, Edward H. Rosson, manager.
- WHB, Kansas City, Mo. (Central, 411), 8-9 p. m.,** Margaret Barclay, pianist, playing "The Tyrant Nymph" and "Volek"; Mable Lynn Tuttle, readings; Mrs. Harry W. Hanlon, soprano, singing "The Shoogly

## Tuesday, December 9

- Tuesday, silent night for: CHNC, KFAE, KFDM, KFGZ, KOB, WAAW, WBBR, WCAU, WCBD, WDBY, WEAF, WHA, WHO, WMH, WOO, WOS.
- CKAC, Montreal, Can. (Eastern, 425), 7 p. m.,** kiddie's stories in French and English; 7:30, Mount Royal hotel concert orchestra; 8:30, Frontenac Breweries entertainers; 10:30, Mount Royal hotel dance orchestra.
- CKY, Winnipeg, Can. (Central, 450), 7:30 p. m.,** university lecture; 8:15, studio concert.
- KFI, Los Angeles, Calif. (Pacific, 469), 6:45-8 p. m.,** Aeolian pipe organ recital, Dan McFarland, organist; 8-9, Footbill quartet; 9-10, Examiner; community program; 10-11, Packard ballad hour.
- KFKB, Milford, Kans. (Central, 286), 9-10 p. m.,** old time musical program.
- KFNF, Shenandoah, Ia. (Central, 266), 7:30 p. m.,** program, Farmer Puckett.
- KFKX, Seattle, Wash. (Pacific, 238), 7-7:45 p. m.,** children's entertainment; 8-9, Ray Robinson and his Bagdad orchestra; 10-11, orchestra.
- KFSG, Los Angeles, Calif. (Pacific, 278), 6:30-7:30 p. m.,** children's hour, "Uncle Jim," and associates.
- KGO, Oakland, Calif. (Pacific, 312), 8 p. m.,** grand opera, "Cinderella," Lillian Birmingham, Carl Anderson, directors; reading of the fairy tale, "Cinderella," Wilda Wilson Church; Mrs. James F. Pressley, soprano; Lillian Birmingham, contralto; Carl Anderson, tenor; Grace Le Page, soprano; Ruth Waterman, contralto; Beatrice L. Sherwood, soprano; Richard Lungren, bass; 10-1 a. m., Henry Halstead's orchestra.
- KGW, Portland, Ore. (Pacific, 492), 8 p. m.,** agricultural lecture, Oregon Agricultural College Extension service; 8:30, concert, Civic Music club artists; 10, Multnomah Hotel Strollers.
- KHJ, Los Angeles, Calif. (Pacific, 395), 12:30-1:30 p. m.,** children's hour, "Rendezvous Ballroom" orchestra from Ocean Park; 2:30-3:30, matinee musicale; 6-6:30, Art Hickman's concert orchestra; 6:30-7:30, weekly visit, Queen Titania and Sandman from Fairyland, bedtime story, Uncle John; 8-10, program,



Wednesday, December 10

(Continued from page 13)

WHK, Cleveland, Ohio (Eastern, 283), 6 p. m., Ponce de Leon orchestra, Herbert Hayward, director, Grebe's Hanna Building restaurant; sports, news; 7, Ethel O. Hawes, bedtime story.

WHN, New York, N. Y. (Eastern, 360), 6:30-7 p. m., Alamae orchestra; 7:30, Club Richmond orchestra; 9:30-10, Ponce de Leon orchestra; 10-11, Clover Gardens orchestra.

WHO, Des Moines, Ia. (Central, 526), 7:30-9 p. m., Bankers Life Radio orchestra, W. L. Marsh, director; Christmas story, Santa Claus; Thelma Rhynsbarger, soprano.

WIP, Philadelphia, Pa. (Eastern, 509), 6:05 p. m., Aunt Coogan and his Club Madrid orchestra; 7, Uncle Wip's bedtime stories.

WJJD, Mooseheart, Ill. (Central, 278), 7:15-8:15 p. m., Junior band; pupils, Misses Geiss, Tillery, English.

WKAQ, San Juan, P. R. (Intercolonial, 360), 8-9:30 p. m., Municipal band, Jesus Figueroa, director.

WLW, Cincinnati, Ohio (Central, 423), 8 p. m., Santa Claus hour; 8, Chub-Ernieberg orchestra; 8:45, drama, "The Joy of Living," directed by Mrs. Henry Flarsheim; 8:55, Formica band and orchestra.

WMH, Cincinnati, Ohio (Central, 309), 8 p. m., Blue Grass orchestra; cello solos, Oscar Kriese; 9, talk, "Bits of Cincinnati History," George W. Platt; violin solos, Eugene Perazzo, David Brinkmoeller, accompanist; 9:30, Abbott's orchestra.

WNJ, Newark, N. J. (Eastern, 233), 10:30-12:30 a. m., Frank Dally and his Meadowbrook orchestra.

WOC, Davenport, Ia. (Central, 484), 8 p. m., Erwin Swindell, organist; Howard A. Carroll, tenor.

WOO, Philadelphia, Pa. (Eastern, 509), 7:30 p. m., A. Candelieri and his Hotel Adelphi concert orchestra; 8, Harriette C. Ridley, soprano; 9, Grace Garden dance orchestra; 10:30, Vincent Rizzo and his Hotel Sylvania dance orchestra.

WOR, Newark, N. J. (Eastern, 405), 6:15-7 p. m., "Music While You Dine," Walter Feldkamp's Villa Francaise orchestra; 6:45-7, resume of the day's sports; 8-8:15, Gene Ingraham's orchestra; 8:15-8:30, Chalfin-classical dancing orchestra; 8:30-8:45, Wallace Hermann, tenor; 8:45-9, talk, Major Pratt; 9:15-9:30, Major Pratt; 9:30-10, music; 10-10:30, quartet and orchestra; 10:30-11, dances; 11-11:30, quartet and orchestra.

WOS, Jefferson City, Mo. (Central, 440.9) 8 p. m., "Feeding for Winter Eggs," H. L. Kempster; 8:15, "The Rural Schools and County Life," D. Henry Curtis; 8:30, old time fiddling, Bill Caton, Oia Cathright.

WQJ, Chicago, Ill. (Central, 448), 7-8 p. m., dinner concert, Ralph Williams and his Rainbo Garden orchestra; Morrie Boyd Mitchell, soprano; James Mitchell, baritone; Rev. Karl Scheroffski, pianist; 10-2, Ralph Williams and his Rainbo Slarkys; Fred Jacobsen, monologist; Sandy Meek, Scotch tenor; the Melodians, Laurie, Eddie, Bennie; Clarence Theodor, tenor; Rita McFawn, soprano.

WTAM, Cleveland, Ohio (Eastern, 390), 6 p. m., Guy Lombardo's Royal Canadians orchestra; 8, program arranged by the Cleveland Plain Dealer.

WTAS, Elgin, Ill. (Central, 286), 6-8 p. m., Tip Top Inn string sextet; 8-12, Terrace Garden dance program, Fred Hamm and his orchestra; Jimmy Eggert, Lew Butler, Joe Stool.

WTAY, Oak Park, Ill. (Central, 283), 6:45-7:45 p. m., George H. Clark, organist; 9-9:45, 10:15-11:15, Axel Christensen, pianist; ten minute technical talk, member staff Radio Age; Guyon's Paradise Ballroom orchestra.

WWJ, Detroit, Mich. (Eastern, 517), 7 p. m., The Detroit News orchestra; Chas. Coates, baritone; Cora Joan Haussler, soprano.

CHRISTY AND HORN FEATURES AT WGR



This handsome young man is E. M. "Christy" Christian, player of the bass horn in the Vincent Lopez Hotel Statler dance orchestra of which Harold Gieser is director. If you want to learn more about this instrument, tune in for WGR, Monday, December 7. "Christy" and the horn will be the features this week. See the Digest program pages for time on the air. The horn is not shown because it is so big the space devoted to "Christy's" features would have to be cut down, and that would never do.

Colegrove Studio, Buffalo.

WJY, New York, N. Y. (Eastern, 405), 8-8:30 p. m., Seiser and his Confrontations; 10:15-11, dance program, Al Reiser and his Confrontations.

WKAR, San Juan, P. R. (Intercolonial, 360), 8:30-10 p. m., musical concert, Cafe-Restaurant "La Cafetera."

WLW, Cincinnati, Ohio (Central, 423), 6 p. m., Santa Claus hour; 10, Doherty's orchestra; 10:30, Milnor instrumental trio; 11, tenor solos, Carl R. Cornuelle; 11:15, Doherty orchestra's mid-night concert.

WMC, Memphis, Tenn. (Central, 500), 8 p. m., bedtime story, Uncle Percy; 8:30, Hotel Chisca orchestra, Prof. Frank Pappalardo, director; 9:30, Addy Britt and Dick Finch.

WMH, Cincinnati, Ohio (Central, 309), 8 p. m., popular songs, Wright and Bissinger; organ selections, Kinkel; piano solos, Rudy Germaine; 9, Avon dance orchestra.

WOAW, Omaha, Neb. (Central, 526), 6 p. m., every child's story hour, Grace Sorenson; 6:25, selections on the harp-guitar and Zither by Kuhn and Leeder; 6:45, dinner program, Ash Stratton's orchestra; 9, Speilberger's concert orchestra; 10:30, Wow! Frolic, Frank Lodele.

WOC, Davenport, Ia. (Central, 484), 9 p. m., The Schuster Sisters' orchestra; 11, Louis Connor and his LeClaire hotel orchestra; song and novelty numbers, Peter MacArthur.

WOR, Newark, N. J. (Eastern, 405), 6:15-6:30 p. m., "Radio for the Layman," Albert E. Sonn; 6:30-7, Jimmie Lent's orchestra; 7:15-7:30, resume of the day's sports.

WQJ, Chicago, Ill. (Central, 448), 7-8 p. m., dinner concert, Ralph Williams and his Rainbo Garden orchestra; Dorothy Davis Dillow, Soprano; Manuel Rodriguez, tenor; Lydia Lochner, contralto; Marion Henry, accompanist; Kathryn Snyder, reader; 10-2, Ralph Williams and his Rainbo Slarkys; Rosemary Hughes, soprano; Hill, Hirsch, Corny, trio; Grace Wilson, contralto; Axel Christensen, pianist; Joey Stool and Lew Butler; Will Rossier.

WRC, Washington, D. C. (Eastern, 459), 7 p. m., children's stories, Peggy Albion; 7:15, dinner concert, Helen Davis, New Willard hotel orchestra; 8:15, talk, auspices, American Automobile association; 8:45, talk, auspices, Smithsonian Institute; 9:15, concert, Lee House trio; 10:30, dance program, Waldorf-Astoria dance orchestra.

WSA, Cincinnati, Ohio (Central, 309), 10 p. m., sketch, "The Cheerful Companion," Caroline Schlosser, Anna Lucia, baritone solos, Sam Pusateri; Roman quartet, Charles Partington, Fred Hamm and his orchestra; violin; Earl Whitting, cornet; Diddy Brinkley, piano; 10:45, popular songs, Wright and Bissinger.

WTAM, Cleveland, Ohio (Eastern, 390), 6 p. m., Guy Lombardo's Royal Canadians orchestra.

WTAS, Elgin, Ill. (Central, 286), 6-8 p. m., dinner program, Tip Top Inn string sextet; 8-12, Terrace Garden dance program, Fred Hamm and his orchestra.

WTAY, Oak Park, Ill. (Central, 283), 6:45-7:45 p. m., Leon Switzer, baritone; Dr. Hugh B. Marshall, tenor; Helen Rau, pianist; 9-9:45, 10:15-11:15, Ellen Connor, soprano; Jimmy Wall, tenor; Guyon's Paradise Ballroom orchestra.

WWJ, Detroit, Mich. (Eastern, 517), 7 p. m., The Detroit News orchestra; Mrs. May F. Cowperthwaite, soprano; 10, Jean Goldkettes dance orchestra.

Friday, December 12

Friday, silent night for: CHNC, KFAE, KFDM, KFDZ, KGW, KOB, KGD, WCAU, WHA, WHO, WJJD, WNJ, WOO, WOS.

CKAC, Montreal, Can. (Eastern, 425), 8:30 p. m., Canadian National Railway, CNRM.

CKY, Winnipeg, Can. (Central, 450), 7:30 p. m., Esperanto lesson; 8, CNRW, Canadian National Railway's program.

KFI, Los Angeles, Calif. (Pacific, 469), 6:45-7 p. m., Y. M. C. A. speaker; 7-7:30, dance orchestra; 7:30-8, Maud Reeves, soprano; 8-9, instrumental trio; 9-10, Examiner: community program; 10-11, vocal recital.

KFKB, Milford, Kan. (Central, 286), 10-11 p. m., lecture, Dr. Osborn, musical; 11-12, Dr. Brinkley.

KFKX, Hastings, Neb. (Central, 291), 9:30-11 p. m., program, auspices Baptist College of Grand Island.

KFN, Shenandoah, Ia. (Central, 266), 7:30 p. m., concert, Lutheran church of Germantown.

KFQX, Seattle, Wash. (Pacific, 238), 7-7:45 p. m., children's entertainment; 8-9, Ray Robinson and his Bagdad orchestra; 10-11, orchestra.

KFSG, Los Angeles, Calif. (Pacific, 278), 10:30-11:30 a. m., Sister McPherson's personal hour; Bible school of the air; 3:30-4:30 p. m., afternoon organ recital, Roy Reid Brignall; 7:30-8:30, matinee service, sermon, Aimee Semple McPherson; 9:15-10, choir and Silver band; 10-11, organ recital, Esther Fricke Green.

KGO, San Francisco, Calif. (Pacific, 312), 8 p. m., KGO instrumental trio; Elizabeth Van Etten, contralto; Lorraine Ewing, pianist; "The Customs of India," Ford E. Samuel; Edwin Heinon, baritone; Julia Hanna, Contralto, violinist; "Hidden Powers," Dr. S. R. Mandal; Franklyn B. Grant, saxophonist; Mrs. Homer Henley, soprano; Joziema von der Ende, cellist; Homer Henley, baritone; 10-11 a. m., Henry Halstead's orchestra.

KHJ, Los Angeles, Calif. (Pacific, 395), 12:30 p. m., Karl Brandenburg, tenor; 2:30-3:30, matinee musical; 6-6:30, Art Heiman's concert orchestra; 6:30-7:30, Prof. Walter Sylvester Hertzog, stories of American history, pupils of Carter Weaver; 7:30-8, Harold Swartz, talk on art; 8-10, program presented by Huntington Beach, Calif., chamber of commerce; 10-11, Earl Burnett's Biltmore hotel dance orchestra.

KIS, Los Angeles, Calif. (Pacific, 360), 8-9 p. m., organ recital; soprano and baritone solos.

KKX, Hollywood, Calif. (Pacific, 337), 6-7:30, dinner music; 7:45, J. R. Douglas, talk on securities; 8-9, Lindsay's dance orchestra; 9-10, Paul G. Hoffman's Studebaker dance orchestra; 10-11, Abe Lyman's Coconut Grove dance orchestra from Ambassador Hotel.

KPO, San Francisco, Cal. (Pacific, 423), 7-7:30 p. m., Rudy Seiser and his Fairmont hotel orchestra; 8-9, organ recital, Theodore J. Irwin; 9-10, Maude Goodwin, dramatic soprano; J. D. Palmer, baritone; Susan Cole, violinist; Agnes Callaghan, pianist; 10-11, E. Max Bradford's versatile band.

KYW, Chicago, Ill. (Central, 536), 7-7:30 p. m., dinner concert, Congress hotel; 8-8:20, Twenty Minutes of Good Reading, Roy E. Fernin; 8:20-9:15, musical program; 9:20, "Safety First," talk, Z. C. Elin; 10-11:30, evening at home.

WAAW, Omaha, Neb. (Central, 286), 8-9 p. m., educational program, Rev. Brown, W. J. Martin; bridge talk, Mrs. Purdy.

WBRR, New York, N. Y. (Eastern, 273), 9-10 p. m., Staten Island School of music, Clifford Chapin, Edward E. C. Cooper, Lelah Koval; 9:25, Clifford Chapin, violinist; 9:30, International Sunday school lesson, S. M. Van Sipma; 9:50, Lelah Koval, pianist; 10, Staten Island School of music.

WBZ, Springfield, Mass. (Eastern, 337), 6-7 p. m., dinner concert; 7:10, kiddies' bedtime stories; 7:15-7:30, lectures and addresses; 8:30-10:30, concert.

WCAE, Pittsburgh, Pa. (Eastern, 462), 6:30 p. m., dinner concert, William Penn hotel; 7:30, Uncle Kay-see; 8, special feature; 8:15, special feature; 8:30, musical program, artists, Prof. Joseph Moore's studios.

WCAL, Northfield, Minn. (Central, 360), 9 p. m., Confort Hinderlie, pianist; Ella Hjertaas, contralto; College quartet; Osmond Westley, Obed Grinder, Matthew Lyders, Kenneth Onsgaard.

WCAY, Milwaukee, Wis. (Central, 266), 10:30 p. m., Arcadia Ballroom orchestra; Billy Williams, vocalist; Jerome Treis, cornetist; Mrs. Fischer, Mrs. Radke, vocal duetists.

WCBD, Zion, Ill. (Central, 345), 8 p. m., mixed quartet; vocal duets, Thomas, Barton; vocal duets, Beem, Crowe; Buelah Mitchell, soprano; Chester S. Bagg, baritone; Mrs. P. M. LaRose, contralto; Daniel Mason, trombonist.

WJY, New York, N. Y. (Eastern, 405), 8-8:30 p. m., Seiser and his Confrontations; 10:15-11, dance program, Al Reiser and his Confrontations.

WKAR, San Juan, P. R. (Intercolonial, 360), 8:30-10 p. m., musical concert, Cafe-Restaurant "La Cafetera."

WLW, Cincinnati, Ohio (Central, 423), 6 p. m., Santa Claus hour; 10, Doherty's orchestra; 10:30, Milnor instrumental trio; 11, tenor solos, Carl R. Cornuelle; 11:15, Doherty orchestra's mid-night concert.

WMC, Memphis, Tenn. (Central, 500), 8 p. m., bedtime story, Uncle Percy; 8:30, Hotel Chisca orchestra, Prof. Frank Pappalardo, director; 9:30, Addy Britt and Dick Finch.

WMH, Cincinnati, Ohio (Central, 309), 8 p. m., popular songs, Wright and Bissinger; organ selections, Kinkel; piano solos, Rudy Germaine; 9, Avon dance orchestra.

WOAW, Omaha, Neb. (Central, 526), 6 p. m., every child's story hour, Grace Sorenson; 6:25, selections on the harp-guitar and Zither by Kuhn and Leeder; 6:45, dinner program, Ash Stratton's orchestra; 9, Speilberger's concert orchestra; 10:30, Wow! Frolic, Frank Lodele.

WOC, Davenport, Ia. (Central, 484), 9 p. m., The Schuster Sisters' orchestra; 11, Louis Connor and his LeClaire hotel orchestra; song and novelty numbers, Peter MacArthur.

WOR, Newark, N. J. (Eastern, 405), 6:15-6:30 p. m., "Radio for the Layman," Albert E. Sonn; 6:30-7, Jimmie Lent's orchestra; 7:15-7:30, resume of the day's sports.

WQJ, Chicago, Ill. (Central, 448), 7-8 p. m., dinner concert, Ralph Williams and his Rainbo Garden orchestra; Dorothy Davis Dillow, Soprano; Manuel Rodriguez, tenor; Lydia Lochner, contralto; Marion Henry, accompanist; Kathryn Snyder, reader; 10-2, Ralph Williams and his Rainbo Slarkys; Rosemary Hughes, soprano; Hill, Hirsch, Corny, trio; Grace Wilson, contralto; Axel Christensen, pianist; Joey Stool and Lew Butler; Will Rossier.

WRC, Washington, D. C. (Eastern, 459), 7 p. m., children's stories, Peggy Albion; 7:15, dinner concert, Helen Davis, New Willard hotel orchestra; 8:15, talk, auspices, American Automobile association; 8:45, talk, auspices, Smithsonian Institute; 9:15, concert, Lee House trio; 10:30, dance program, Waldorf-Astoria dance orchestra.

WSA, Cincinnati, Ohio (Central, 309), 10 p. m., sketch, "The Cheerful Companion," Caroline Schlosser, Anna Lucia, baritone solos, Sam Pusateri; Roman quartet, Charles Partington, Fred Hamm and his orchestra; violin; Earl Whitting, cornet; Diddy Brinkley, piano; 10:45, popular songs, Wright and Bissinger.

WTAM, Cleveland, Ohio (Eastern, 390), 6 p. m., Guy Lombardo's Royal Canadians orchestra.

WTAS, Elgin, Ill. (Central, 286), 6-8 p. m., dinner program, Tip Top Inn string sextet; 8-12, Terrace Garden dance program, Fred Hamm and his orchestra.

WTAY, Oak Park, Ill. (Central, 283), 6:45-7:45 p. m., Leon Switzer, baritone; Dr. Hugh B. Marshall, tenor; Helen Rau, pianist; 9-9:45, 10:15-11:15, Ellen Connor, soprano; Jimmy Wall, tenor; Guyon's Paradise Ballroom orchestra.

WWJ, Detroit, Mich. (Eastern, 517), 7 p. m., The Detroit News orchestra; Mrs. May F. Cowperthwaite, soprano; 10, Jean Goldkettes dance orchestra.

Friday, silent night for: CKAC, CHNC, KGO, KIS, KPO, WLA, WBBR, WCB, WGBY, WEAD, WJAX, WKAQ, WLW, WMH, WRC, WSAI.

CKY, Winnipeg, Can. (Central, 450), 7:30 p. m., lecture, Prof. Jackson; 8:15, studio concert.

CNRT, Toronto, Can. (Eastern, 400), 8:30 p. m., program, Harbour Conservatory of music; Bernadoff quintet, Harold Bardley, pianist; William Hardiman, violinist; Sam Hershenson, violinist; Nathan Green, violist; Brahm Sand, violin-cellist; Robert Pogue, tenor.

KFAE, Pullman, Wash. (Pacific, 330), 7:30 p. m., Ed Hyde, baritone; Harold Vogle, baritone; Herbert Barstow, "Essentials of Successful Farm Management," George Severance; "One Phase of Home Management," George Gallup; book chat, Alice L. Webb.

KFDM, Beaumont, Tex. (Central, 306), 8 p. m., band concert.

KFI, Los Angeles, Calif. (Pacific, 469), 5:30-6 p. m., Examiner: news bulletins; 6:45-8, Aeolian pipe organ recital, Dan McFarland, organist; 8-9, Evening Herald; Fullerton, Calif., community program; 9-10, Examiner: vocal recital; 10-11, Sorority Six orchestra.

KFKB, Milford, Kan. (Central, 286), 10-11 p. m., lecture, Dr. Osborn, musical; 11-12, Dr. Brinkley.

KFN, Shenandoah, Ia. (Central, 266), 7:30 p. m., concert, Julian, Nebr., Mrs. Sterling Wilberger, director.

KFX, Seattle, Wash. (Pacific, 238), 7-7:45 p. m., children's entertainment; 8-9, Ray Robinson and his Bagdad orchestra; 10-11, orchestra.

KFSG, Los Angeles, Calif. (Pacific, 278), 10:30-11:30 a. m., sunshine hour; 3:30-4:30 p. m., organ recital, Roy Reid Brignall; 7:30-9:15, Judge C. S. Hardy, talk; sermon, Aimee Semple McPherson; silver band; 9:15-10, silver band, direction G. N. Nichols; N. E. Brignall, Radio talk; 10-11, organ recital, Roy Reid Brignall.

KGW, Portland, Ore. (Pacific, 492), 8 p. m., popular lecture, University of Oregon; 10:30, Hoot Owls, Orioles of Salem.

KHJ, Los Angeles, Calif. (Pacific, 395), 12:30 p. m., program of news and music; 2:30-3:30, matinee program, 6-6:30, Art Heiman's concert orchestra; 6:30-7:30, Prof. Walter Sylvester Hertzog, stories of American history; "Sir" Richard Hedrick and Viola Von, screen starlets; 8-9:30, program, Chesley Finance corporation; 9:30-10, Piggly Wiggly girls trio; 10-11, Earl Burnett's Biltmore hotel dance orchestra.

KX, Hollywood, Calif. (Pacific, 337), 6-7:30 p. m., dinner hour music; 7:45, morning; 8-9, feature program, Eastern Outfitting company; 9-10, feature program, Columbia Outfitting company; 10-11, Johnny Ogden's dance orchestra; 11-12, Abe Lyman's Coconut Grove dance orchestra.

KOB, State College, N. M. (Mountain, 360), 7:30-8:30 p. m., music, musical department, New Mexico College of Agriculture and Mechanics.

KYW, Chicago, Ill. (Central, 536), 7-7:30 p. m., dinner concert, Congress hotel; 7:30-8, program, Duncan Sisters Music Publishing company; 8, speeches, auspices American Farm Bureau federation; 9-10, mid-night revue; 11-2:30, Coon-Sanders Original Night-club.

WBAV, Columbus, Ohio (Eastern, 423), 8 p. m., program, musical faculty, Wittenberg college, Springfield, Ohio, directed by Frederick L. Bach.

WBZ, Springfield, Mass. (Eastern, 337), 6-7 p. m., dinner concert; 7:10, kiddies' bedtime stories; 7:15-7:30, lectures and addresses; 8:30-10:30, concert; 10-11:30, concert; 11:30-12, dance program, McEnelly's slinging orchestra.

WCAE, Pittsburgh, Pa. (Eastern, 462), 6:30 p. m., dinner concert, William Penn hotel; 7:30, Uncle Kay-see; 8, special feature; 8:15, special feature; 8:30, musical program, artists, Prof. Joseph Moore's studios.

WCAL, Northfield, Minn. (Central, 360), 8:30 p. m., book talk, Bradford's "Bare Souls," Dr. George Weida's Spoken.

WCAY, Philadelphia, Pa. (Eastern, 278), 6 p. m., Meyer Davis Hotel Pennsylvania dance orchestra, direction Louis Baer; 8, recital.

WCAY, Milwaukee, Wis. (Central, 266), 8 p. m., Oswald Jaeger night, Reg Peppers band; Billy Hunter, Scotch comedian; H. M. Callahan, baritone horn soloist; Eulalia Pross, mezzo soprano.

WCCO, Minneapolis-St. Paul, Minn. (Central, 417), 6:30 p. m., Dick Long's Nankin cafe orchestra; Coilla Dare, singing comedienne; Adrian Ivens, accompanist; 7:30, lecture hour; 8:30, Twin City Lines band; Harry Larsson, director.

WCX, Detroit, Mich. (Eastern, 517), 6 p. m., dinner concert, Hotel Tuiler; 10, dance program, Arcadia auditorium.

WDAF, Kansas City, Mo. (Central, 411), 3:30-4:30 p. m., the Star's string trio; 6-7, school of the air, piano tuning-in number on the Duo-Art; Cecilo Burton, readings; the Tell-Me-a-Story Lady; music, Hotel Muehlebach Trianon ensemble; 11:45-1 a. m., Nighthawk frolic, the "Merry Old Chief" and the Plantation players.

WDBY, Chicago, Ill. (Central, 258), 7 p. m., musical program, George S. Schuler, director; Carmen Smith, pianist; Frances Frederickson, Caroline Cedar, Violet Flodin, Ralph Briggs, Carl Blackmore.

WEAF, New York, N. Y. (Eastern, 492), 6-7 p. m., dinner music, Waldorf-Astoria hotel; 7-7:30, services, Federation of Greater churches of New York; 7:45-8, Richard B. Gilbert, aronach; 8:30-9, touring with the Packard Eight; 9-9:30, Honner Harmony Four; 9:30-10:30, Fordham Gleo club; 10:30-10:45, Warren Scofield, baritone.

WEAO, Columbus, Ohio (Eastern, 294), 8 p. m., chimes; talk, "Selecting a Receding Set," Allen M. Rose, electrical engineering department; 8:15, Miss Sada Annis Harbarger, department of English, will read "The King of Boyville," from The Beal Issue, by William Allen White; 8:30, musical program.

WEBB, Chicago, Ill. (Central, 370), 7-8 p. m., Oriole orchestra concert; musical bits, Riviera theater; 9-10, Oriole orchestra; zolf Iosson Amber Andrews; Belle F. Cutter, soprano; 11-12, Oriole orchestra; Harry Davis, baritone; late revue.

WEEI, Boston, Mass. (Eastern, 303), 6 p. m., dance selections, Jack Benard and his Mansion Inn orchestra; 7, Boston Edison Big Brother club; 7:30-10, musicals.

WFAA, Dallas, Tex. (Central, 476), 8:30-9:30 p. m., Pythian band and orchestra, E. W. Jarnagan, director; 11-12, Adolphus hotel orchestra.

WFI, Philadelphia, Pa. (Eastern, 395), 6:30 p. m., Meyer Davis Bellevue Stratford concert orchestra; 7, Sunny Jim, the kiddies' pal; 8, Boy Scouts Radio program.

WGN, Chicago, Ill. (Central, 370), 6-6:30 p. m., Lyon & Healy organ recital; 6:30-7, dinner music; Drake concert ensemble, Blackstone string quintet; 8-9, classic hour; 10-11, Jazz scamper, Jack Chapman's dance orchestra, Don Bestor's orchestra.

WGR, Buffalo, N. Y. (Eastern, 319), 6-7:30 p. m., Halpyrd string quartet.

WGY, Schenectady, N. Y. (Eastern, 380), 6:30 p. m., dinner music, Hotel Ten Eyck orchestra; 7:45, "A Few Moments with New Books," William F. Jacob; 8, WGY orchestra; Helen Radding, pianist.

WHAS, Louisville, Ky. (Central, 400), 7:30-9 p. m., concert, auspices, Mrs. John E. Harmon, Jr.

WHB, Kansas City, Mo. (Central, 411), 8-9 p. m., Mary Endicott Drane, violinist, playing "On Wings of Song" and "Perpetual Motion"; Mrs. Arthur G. Stannard, soprano, singing "Two Little Irish Love Songs," "The Star," "Christmas Eve" and "When Hearts Are Young"; Agnes Patterson, reader; Virginia Drane, violinist, playing "Spanish Dance" and "Minuet"; Gladys Gwynn, pianist, playing "Valse"; 9-10, program arranged by Kate Halpin; music, Gilbert Jaffey's orchestra.

WHK, Cleveland, Ohio (Eastern, 283), 6 p. m., Ponce de Leon orchestra, Herbert Hayward, director, Grebe's Hanna Building restaurant; sports, news; 8 p. m., musical organizations of Lincoln High school, concert.

WHN, New York, N. Y. (Eastern, 360), 6:30-7 p. m., Alamae orchestra; 7:10-7:30, WTN employment broadcasting; 9:30-10, Spear's dance orchestra; 10:30-10:45, Club Madrid orchestra; 12-12:30, Parody club; 12:30-1, Wigwam club.

WIP, Coogan and his Club Madrid orchestra; 7, Uncle Wip's bedtime stories; 8:15, Philadelphia Police band, Lieut. Joseph Kiefer, conductor; 9, talk, auspices United Synagogue of America; 10:30, Harvey Marburger and his Vaudeville orchestra.

WJAX, Cleveland, Ohio (Eastern, 390), 7 p. m., Ponce de Leon orchestra, Herbert Hayward, director, Grebe's Hanna Building restaurant; instrumental and solo numbers, popular entertainers.

Astor Coffee orchestra; 10-10:15, Dorothy H. Burke, dramatic soprano.

WEBB, Chicago, Ill. (Central, 370), 7-8 p. m., Oriole orchestra concert; musical bits, Riviera theater; Dean Remick, pianist; 9-10, Frederick Agard, tenor; Oriole orchestra; Rita McFawn, soprano; 11-12, Oriole orchestra; three musketeers, songs; Sandy Meek, tenor.

WEI, New York, N. Y. (Eastern, 273), 7-7:15 p. m., Hybruns' review of new plays; 7:15-7:45, Harriet Donaldson and his Society orchestra; 8-8:15, Mary Cecelia Humbueler, pianist, 11-year-old freman's daughter; 8:15-8:45, May Singh Breen and her Syncopters.

WEEI, Boston, Mass. (Eastern, 303), 6:30 p. m., Dok-Eisenbourg and his Simonfons; 7, Boston Edison Big Brother club; 7:30, "A Few Minutes with Santa Claus"; 8, musical; 9-10, program, B. Fischer & company's Astor Coffee orchestra.

WFAA, Dallas, Tex. (Central, 476), 8:30-9:30 p. m., musical program, J. Abner Sage; Elizabeth Gay Jones, pianist.

WFI, Philadelphia, Pa. (Eastern, 395), 6:30 p. m., Meyer Davis Bellevue Stratford concert orchestra; 7, Sunny Jim, the kiddies' pal; 8, Boy Scouts Radio program.

WGN, Chicago, Ill. (Central, 370), 6-6:30 p. m., Lyon & Healy organ recital; 6:30-7, dinner music, Drake concert ensemble, Blackstone string quintet; 8-9, classic hour; 10-11, Jazz scamper, Jack Chapman's orchestra; 10-11, Vincent Lopez Hotel Statler dance orchestra, Harold Gieser, director; 8-8:15, Santa Claus from J. N. Adams & Company's Toyland; 9-10, joint recital, Agnes Luther Tullis, contralto; Mildred Daugherty Emery, pianist; 10-11, concert program, Central Y. M. C. A.; 11:30, supper-dance music, Vincent Lopez Hotel Statler dance orchestra, Harold Gieser, director.

WGY, Schenectady, N. Y. (Eastern, 380), 7:45 p. m., health talk; 8, drama, "The Bells," WGY players; 10:30, Van Curler Serenaders; Carroll W. Burrill, baritone; Erwin Lasher, xylophonist; Charles E. Witte, pianist.

WHA, Madison, Wis. (Central, 360), 7:45 p. m., cantata story of Christmas, University Methodist church choir, Prof. L. L. Itlis, director.

WHAS, Louisville, Ky. (Central, 400), 7:30-9 p. m., concert, auspices, Town club, Louisville Conservatory of music, Helen Eichenberger, director.

WHB, Kansas City, Mo. (Central, 411), 7-8, original poems, Walt Filkin; piano solos, Eugene Perazzo.

WHK, Cleveland, Ohio (Eastern, 283), 6 p. m., Ponce de Leon orchestra, Herbert Hayward, director, Grebe's Hanna Building restaurant; sports, news; 7, Ethel O. Hawes, bedtime story; 8, musical program and educational forum.

WHN, New York, N. Y. (Eastern, 360), 6:30-7 p. m., Alamae orchestra; 7-7:30, Club Richmond orchestra; 9:30-10, Crystal Palace orchestra; 10:30-11, Roseland dance orchestra; 11:30-12, Cliff Alabam revue; 12-12:30, Parody club orchestra.

WHO, Des Moines, Ia. (Central, 526), 7:30-9 p. m., band concert, Hawkeye band, Prof. D. M. Rice, director; Williamson brothers, banjoists.

WIP, Philadelphia, Pa. (Eastern, 509), 6:05 p. m., Harvey Marburger and his Vaudeville orchestra, featuring Roy Reuber, pianist; Uncle Wip's bedtime stories.

WJJD, Mooseheart, Ill. (Central, 278), 7:15-8:15 p. m., Novelty orchestra.

WJY, New York, N. Y. (Eastern, 405), 8:30-9 p. m., Thomas R. Hall baritone; 9-9:30, Men's Community Bible Class orchestra.

WNJ, Newark, N. J. (Eastern, 233), 10:30-12:30 a. m., Frank Dally and his Meadowbrook orchestra.

WMC, Memphis, Tenn. (Central, 500), 8 p. m., bedtime story, Uncle Joe; 8:30, concert, Britling's Novelty orchestra, Frank Braccante, director; 11, mid-night frolic, Addy Britt and Dick Finch; Mrs. Ethel Backus.

WOAW, Omaha, Neb. (Central, 526), 6 p. m., "Uncle Ross' of World-Herald story hour, conducted by Doris Claire Secord; 6:20, to be announced; 6:30, half-hour musicale, Harry Brader, violinist conductor and Frank Strawn, pianist; 7, to be announced; 7:15, current sport events, Ivan L. Gaddis, sports editor of the Omaha Daily News; 9, program of old-time music, arranged by H. G. Kiddoo; 10:15, to be announced; 10:30, Sammy Heiman's orchestra.

WOC, Davenport, Ia. (Central, 484), 7:20 p. m., "Farm Legislation," Hon. John Hansen; 8, The Pasadenas orchestra.

WOD, Philadelphia, Pa. (Eastern, 509), 8:25 p. m., Erno Rapee and his Radio gang from Fox theater; overture, Fox theater Symphony orchestra; 10:03, organ recital, Harriette G. Ridley; 10:30, Vincent Rizzo and his Hotel Sylvania dance orchestra.

WOR, Newark, N. J. (Eastern, 405), 6:15-6:30 p. m., Neighborhood quartet; 6:30-7, "Aman-in-the-moon stories; 7:15, Neighborhood quartet; 7:45-7:50, resume of the day's sports.

WOS, Jefferson City, Mo. (Central, 440.9), 8 p. m., "Proven Facts About Hog Cholera and Its Control," Homer A. Wilson; 8:15, musical program, students George R. Smith college.

WQJ, Chicago, Ill. (Central, 448), 7-8 p. m., dinner concert, Ralph Williams and his Rainbo Gardens orchestra; Carl G. Linnor, pianist; Ingram Cleveland, violinist; Dorothe Schubert, Jugo-Slav soprano; 10-2, Ralph Williams and his Rainbo Slarkys; Verdi trio; Nubs Allen, contralto; Roger Boys, Larry, Billy; Monogram trio; Frank Blasko, boy tenor; James J. Whelan, tenor.

WTAM, Cleveland, Ohio (Eastern, 390), 6 p. m., Guy Lombardo's Royal Canadians orchestra.

WTAS, Elgin, Ill. (Central, 286), 6-8 p. m., Tip Top Inn string sextet; Bert Davis, Florence Sanger, Lee Sims; 8-12, famous Terrace Garden dance program, Fred Hamm and his orchestra.

WTAY, Oak Park, Ill. (Central, 283), 6:45-7:45 p. m., Sandy Meek, baritone; Jimmy Whalen, tenor; Black Cat orchestra; 9-9:45, 10:15-11:15, Harry Sosnik and Ray Crock, pianists; Guyon's Paradise Ballroom orchestra.

WWJ, Detroit, Mich. (Eastern, 517), 7 p. m., The Detroit News orchestra; Anne Campbell, The Detroit News poet.

WGY Aids Al Smith in Rescuing Animals

Broadcasts Warn Hunters of Fire Hazards in Woods

SCHENECTADY, N. Y.—Radio filled an important part in putting into effect the proclamation of Governor Al Smith, prohibiting hunting and camping in the Adirondacks and Catskills during the recent dangerous fire hazard.

The facilities of WGY, General Electric station within 150 miles of the hunting country, were used and announcements giving warning of danger were broadcast. Many of the hunters carry Radio sets into the woods; fire and game wardens have receiving sets in their homes and practically all the hotels catering to hunters are equipped with sets.

Georgia Governor Receives Warm Welcome from Public

ATLANTA, Ga.—Atlanta's great Radio audience and thousands of distant hearers were guests at Ansley Park's house-warming for Governor Clifford Walker, recently, a unique event relayed by WSB from the magnificent mansion on the hill overlooking The Prado.

The Ansley Park neighborhood turned out en masse to welcome the distinguished new residents and the party was a huge success.



# “Low Loss,” What It Is and Why

By Jacques Fournier

IN THE previous two articles on low loss in Radio apparatus, inductances were taken up in some detail. In these articles we endeavored to describe the construction of two different units that would keep down the distributed capacity, the ohmic resistance, and the Radio frequency resistance. Inductances are only half the battle, however, and since inductances must be tuned with condensers, condensers are of equal importance. We will now consider several makes of variable condensers on the market which show in their designs and construction a serious effort to keep down the ohmic and high frequency resistance.

### The Buell Condenser

The first of these is shown in Figure 1 and many will recognize it as the condenser designed by E. T. Flewelling and manufactured by the Buell Manufacturing company. The ohmic resistance has been kept down in this condenser by securing the fixed plates in a die-cast strip at three points which insures their not warping and good electrical contact with every plate. The shaft has been die cast around the rotor plates and positive contact is thus assured at this point. At the rear end of the condenser, within the heavy supporting frame, pigtail is securely fas-

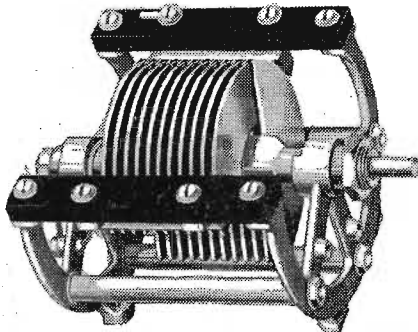

Figure 1.

tened to the shaft and to one of the support pieces which take the place of an end plate on this condenser. Thus, if connection is made to one of the screws which hold the stator in place and to the

screw which secures the end of the pigtail, low DC resistance at every point is certain.

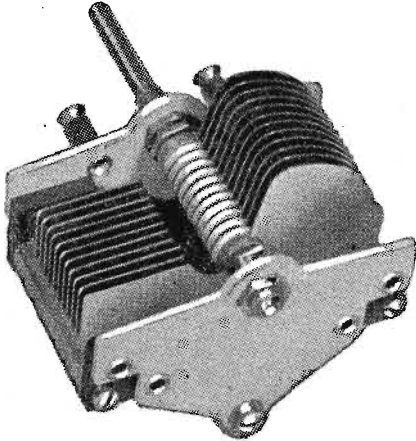

Figure 2.

The high frequency resistance has been cut down by the use of hard rubber strips to which the stator is fastened. The design of this condenser leaves a generous portion of hard rubber between the stator and the rotor and very little is lost through leakage in these strips. The method of mounting this condenser on the panel is such that even if the holes for mounting are not accurately placed no disalignment of the plates will occur and a positive stop for the rotor plates is assured by the construction of the casting at the front of the condenser and the pin on the shaft near the front end. This condenser is a little large, but very low losses result from its use and fans may use it without hesitation.

### D. X. L. Is Different

An entirely different method of obtaining low losses is used in the condenser shown in Figure 3, which is the condenser known as the D. X. L., made by the D. X. L. Radio corporation. The side members supporting the stator plates are in this case made of metal and these are secured to small flat pieces of hard rubber at the ends which are in turn secured to the end

plates. The effective distances between rotor and stator plates is not as great in this case, but amply sufficient to keep down leakage. The end plates are made of very heavy aluminum which assures rigidity of the entire assembly, while the actual plates themselves are made of brass. The stator plates are firmly soldered to the side members assuring perfect electrical contact and permanently accurate spacing, while the rotor plates are soldered to the shaft.

Although this condenser does not have a pigtail, the brass bushings and phosphor bronze spring washers insure excellent electrical contact and practically no loss due to DC resistance. The spring washers are of the split type which make sufficient friction to make unnecessary the use of a counter balance. This condenser will be found to come very close to the rated capacity in each of the four sizes in which it is made.

### The Unique Bradley Condenser

In Figure 3 we show a condenser which has recently been placed on the market by a concern which has made quite a reputation for itself in the manufacture of variable resistances. This is the Bradley condenser made by the Allen-Bradley company. Its construction is unique, al-

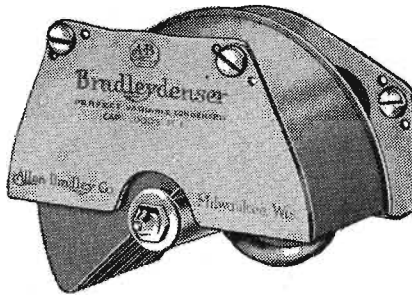

Figure 3.

though adhering to all the known rules for getting low losses. It is the only condenser including a dust cap. Attention is called to the fact that this condenser has but one bearing, that being

at the front end with a hollow stem projecting back through the stator plates. The rotor plates are firmly soldered to a

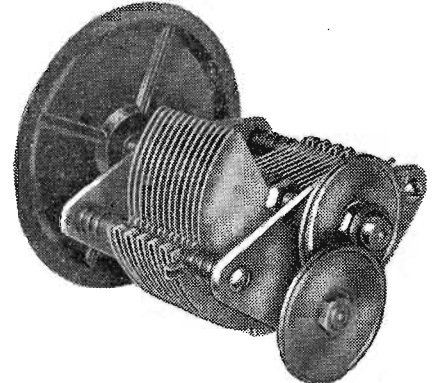

Figure 4.

long hollow tube which slides over the stem mentioned. Thus a bearing is provided which supports the rotor plates at several points along the length of the stem and tube. Metal end plates are provided, as required by the present accepted theories on condenser construction, the stator plates being attached to the end plates toward the front of the panel by dielectric material of the highest quality.

Low ohmic resistance is assured by the fact that all plates are soldered either to the side members or the shaft, and low high-frequency resistance can be counted on due to the fact that only two small pieces of dielectric are used in the construction. This condenser has much of merit to recommend it to the home constructor.

### U. S. Tool Is Solid Job

In Figure 4 we show a condenser made by the U. S. Tool company which is one of three types made by that concern. The one shown provides metal end plates and vernier adjustment of the rotor plates. The most unusual feature is the fact that the stator plates are all stamped out of

(Continued on page 18)

## NOLOSS

TRADE MARK

### What Does It Really Mean?

NOLOSS is a trademark that identifies a condenser in which the loss is so small that you can't measure it. There is no other condenser that even approaches this perfection. Think what that means to your set. NOLOSS is bound to change results. Better reception! The secret lies in the General Instrument Corporation's insulating with AIR, ISOLANTITE, PYREX, CORANTUM and QUARTZ. Prove it to yourself by putting NOLOSS into your circuit.

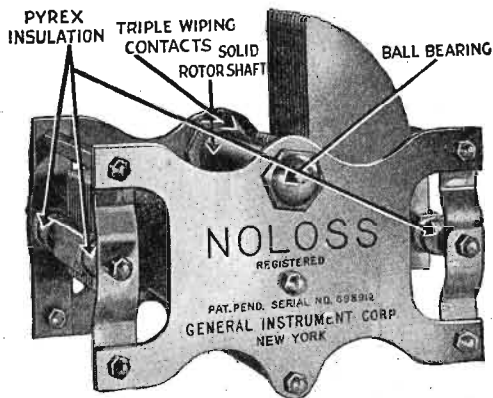

Type	Maximum Capacity	Minimum Capacity	Price
51X	.00025 mfd.	9 mmfd.	\$6.00
51A	.0003 mfd.	11 mmfd.	6.00
51D	.0005 mfd.	13 mmfd.	6.50
51F	.001 mfd.	20 mmfd.	7.00
52D	.0005 mfd.	13 mmfd.	9.00
52F	.001 mfd.	20 mmfd.	9.50

At your dealer's or direct from

**GENERAL INSTRUMENT CORP.**

423 Broome Street  
NEW YORK CITY



### SHAMROCK-HARKNESS KIT

Contains all parts to build the Shamrock-Harkness Reflex

The set for the Masses as well as the Classes

Suppose you could build the three leading circuits

THEN PICK THE BEST FEATURE OF EACH AND COMBINE THEM IN ONE

SHAMROCK engineers have done it for you. In perfecting the new Shamrock-Harkness, they have combined the distance of the Neutrodyne with the clarity of the Reflex and the volume of the Regenerative.

Operates a loud speaker.  
Two tubes do the work of five.  
Cuts battery cost 60 per cent.  
Does not squeal, howl or radiate.  
Stations can be logged—and come in with amazing clearness and volume.

For best results use only genuine Shamrock-Harkness licensed parts.



Licensed under U. S. Patent Office Serial No. 719,264 for Radio Receiver Systems.

**\$35**

Before building your set send for booklet

SHAMROCK MANUFACTURING CO.  
Dept. 27-C, Market St. Newark, N. J.

**SHAMROCK**  
FOR SELECTIVE TUNING

SHAMROCK MFG CO., Dept. 27-C, Market St., Newark, N. J.

I enclose 10 cents (U. S. stamps or coin) for copy of "Shamrock Radio Builder's Guide Book," containing diagrams and complete instructions for building 10 sets at prices ranging from \$15 to \$50.

Name .....

Address .....

Dealer's Name.....

# Radio Digest

PROGRAMS  
Illustrated

Published by the Radio Digest Publishing Company, Inc.  
510 North Dearborn Street  
Telephone: State 4372, 4373, 4374, 4375  
Chicago, Illinois

E. C. RAYNER, Publisher

Eastern Office, 611-12 Times Bldg., Times Sq., New York;  
Telephone Bryant 4909, 10462

Member of the Audit Bureau of Circulations

241  
PUBLISHED WEEKLY

#### SUBSCRIPTION RATES

Yearly in U. S. and Possessions and Canada, \$5.00  
Foreign postage, \$1.00 additional Single copies, 10 cents.

Vol. XI Chicago, Saturday, December 6, 1924 No. 9

## World's Show

### Attendance Shows Which Way the Wind Blows

IF YOU have had any doubts about Radio and the position it takes in the average American homes you should have attended the recent show in the Coliseum at Chicago, that is, if you had the chance to get in. The Coliseum management has recently added at least a third more space to the main building at the north end, and with this added area the floor space was not large enough to accommodate the crowds.

The second night of the show gave a record of attendance in that building. In no other show in the history of the institution has there ever been such a crowd. The attendance was so great that admittance was allowed only when others of a like number came out. Each show of the year has been a great deal better than the last one, and the Chicago show, just closed, has capped the climax. We do not know at the present time just where or to what extent the Radio business will reach. If the attendance to the show is any criterion, then we must buckle up the girdle and snap into it.

## What Boomed Radio?

### Free Use of the Air Is Much in Evidence

IN THE whole history of the country no industry has shown such rapid development as Radio. And in no other industry can responsibility for that development be fixed. History tells us that before the advent of the present administration there was not a single broadcasting station. Now there are approximately five hundred and fifty such stations in operation. With the start of Radio telegraphy and later the introduction of the vacuum tube, and much ingenious apparatus, has made possible the Radio as we know it today.

In no other country in the world has the government taken so enlightened a view of broadcasting. Countries abroad have kept Radio within certain limits that gave little chance for any advancement. Broadcasting, if permitted at all, is done only under the most stringent limitations, and receiving sets are usually allowed only to those who pay a license for the privilege and whose names, addresses, occupations, etc., are made a matter of careful public record. Contrast that discouraging condition with the privilege enjoyed by Americans, twenty millions of whom owe their Radio entertainment to the highly considerate manner in which the administration has applied our laws to the Radio situation.

## Winter and Ether Waves

### Strength of Radio Signals Increase with Cold Weather

COOLER weather more than doubled the strength of Radio signals transmitted during tests made up recently at the bureau of standards in Washington.

From these tests and other observations made on daylight signals from the long wave transatlantic stations at New Brunswick and Tuckerton, N. J., the engineers of the bureau of standards have concluded that cold weather benefits Radio transmission.

Although strength was found to be quite uniform during most of the year, with the coming of the cold waves of January, 1924, the signals were observed to rise to more than twice their normal strength.

At the same time there were deviations of many degrees in the apparent direction of the sending stations as indicated by the Radio compass, even in the forenoon when long wave compass bearings are generally free from error.

The end of the series of cold waves in January did not at once restore transmission conditions to the uniformity of autumn and early winter, but left a condition of instability which persisted through the comparatively mild cold of February and early March. During this time the signals frequently fluctuated, going to high values for a few hours and then returning to normal without any obvious connection with weather conditions. After the middle of March these irregularities entirely ceased and transmission again became normal.

## RADIO INDI-GEST

### Radio on the Farm

By Charles L. H. Wagner

"You can take a boy from Hicksville but not Hicksville from the boy," This used to be a saying and was truth without alloy. But today there is no Hicksville for Radio has brought To the farthest country places the city's modern thought.

Now the farm has lost its silence for the music on the air Has brought joy to hearts once lonely and banished many a care, And the boy who lives in Hicksville has just as good a show As the city boy through knowledge that he gets by Radio.

And the farmer's wife no longer has to pine for human voice, Of operas and concerts and lectures she has choice, She can go to church on Sunday though the church is miles away And she learns the news that's current from some station every day.

What a blessing is the Radio to the farmer and his kind, What a stimulus to learning and improving of the mind, Now the farmer in all Hicksvilles is right up-to-date today Since the Radio has brought him the life of old Broadway.

### "Oh! You Think of the Cutest Things"

Dear Indi: Tell me, Indi, dear, did you get all set for an evening's Radio entertainment, put on your head phones and not get a sound. Then commence to tear the stubborn thing down to find that you had your phones on backwards? SQUIBBLABLIBLIUM. P. S. I hesitated sending this, fearing that you might have been knocked off in the tongue war.

### Mrs. Partington Speaks Out

Dear Indi: Mizz Partington has enjoyed a lot of programs endurin the past week. WBZ furnished plenty of classical and violin, while KFNF offers the common and fiddles. WWJ has an orchestra, that she says, is the "knee plus ultra." W O A W has a soprano very pleasing to listen at. WBAP is badly crippled—the Hired Hand has to open and close with a crowbar since his cow neckless (he calls it a "La Valeer" but she can't spell that) has been swiped, but his entertainments is still O. K. WFAA is a willing worker and KFDM comes in smooth and oily. WSB sent her back to the old singin' school in the Greenwood church, in '83, with the "Larboard Watch" duet, while last night Henry Field went him ten years better with a reading of "Fare Thee Well, Brother Watkins—ah." KFKX celebrated first anniversary last night and took first prize at the baby show and had a lot of cute little tricks. Bill Hay just had to sing "Annie Lawrie" and the way he can trill the r's is a sight. He could trill a r, if it come between two z's. KDKA, she says, sent her loud speaker reception of the Pitt-W & J. football game yesterday afternoon, and the announcer made you follow the game so well that you could see it all, if you only closed your eyes, and he made it so you could hear the rooters cheering 225 miles away. WCAE was one of the big stations last night.



SIGNING OFF.

### The Lay of the Last Radi-Knight

Breathes there a man with a soul so dead  
Who never to himself has said  
Ye Gods, this battery is dead  
OH, GOSH.

Or at the time he bought his set  
Never said that he would get  
Stations he's not reached as yet  
'TIS BOSH.

Or when he looked the program o'er  
Didn't say ZY's a bore  
As he dashed it to the floor  
BY GEE.

Yet, when he got KDKA  
Or mayhap one farther away  
Didn't jump around and say—  
THAT'S ME.

L. EDWARD KRALEY.

### "How Dry I Am"

Dear Indi: Did you hear Mr. Volstead's program last Sunday? I did, and this is what the announcer said: "This is Station H2O broadcasting. The next sea-lection will be a dew-wet, 'On the Briny Deep,' sung by members of the 'Moisture' Male Quart-et. Mrs. Sippi at the Dampwater Grand. JACK SNOW.

If you see a beautiful parrot who swears loudly and fluently in Portuguese don't mistake him for a pheasant, just mark his location and notify the postmaster at Fillmore, N. Y. Friends of a Fillmore lady have asked WGY to broadcast for the missing bird; they are afraid that hunters will catch bad habits from him.

INDI HIMSELF.

## Teaching the Teacher?



## Condensed

By DIELECTRIC

Simply because many of us listeners can't afford a swell dinner every night is no valid reason for missing high priced dinner concerts. We don't either! Most often it happens to be an orchestra, but just as I was finishing my third cup of cambric tea we brought in KDKA with an organ concert. At its conclusion there was a feeling of being well fed.

Another pleasing experience was the tuning in of WCAE while Mrs. Jessie Pringle was singing. She had the Nixon restaurant orchestra accompanying her, which made a fine combination.

Boston has its attractions, if you go there by dials. A really good program was presented by musicians at the State theater and Radiocast through WNAC. There are other features put on the air by the Shepard Stores station quite cosmopolitan in nature, and of course the control room is skillfully handled at all times.

Let me tell you something you may know—some don't. You are in search of dance music but want it good. Try them all out. There's plenty of orchestras playing jazz and other dance music, yet, nine times out of ten, you'll turn back to WGN to get Chapman's orchestra.

Don't listen to WTAM while the Hotel Statler orchestra is on the air, unless you have no engagement at any other station, because you'll never get away from the Willard studio 'till they quit.

Migratory birds sometimes fly right through to their destination; then again they may tarry a while on the way. Well, the Seven Musical Magpies tarried at WTAM to make their visit a welcome one. No doubt there are organizations traveling about from studio to studio whose stay at any one place need not be practiced. The listening public doesn't demand it of them. Not at all. Not so the Magpies.

Whenever I hear a voice announcing in a severe-cold-tone I feel morally certain WNAC is holding my attention. So when "the Shepard Stores, Boston" came through the other night I waited to hear a violinist scheduled to appear. Look for the name of Hofburg on Radiocast programs and if it's there, you're in for a pleasant time.

While in Boston we intend to pay our respects to Station WEEL. This station of the Edison company would have a hard time finding a suitable substitute, had the Hampden Institute singers failed to appear for their numbers. They made no mistake in booking these negro singers, for their work was a treat to a good many folk.

During the Radio Exposition in New York city one feature stood out above the others, in so far as Radiocasting from the Grand Central Palace is concerned. Major Andrew White (you all know him), introduced Miss Helen Keller to Mike and the unseen audience. There she was on an equality with the Major; neither could see us. I don't wonder the response to her appeal was so generous. It should be!

WJJD had a speaker tell of the fine points in football tactics which appealed to both men and boys. When the information comes from an authoritative source, it is usual to have complete attention. Whether player or onlooker, gridiron scraps will mean more to any who listened to Mr. Oswald's explanations.



# How to Build the Simplest Possible Super-Het

## Part IV—Answers to Some Questions Asked

By John G. Ryan

**N**O MATTER how carefully one watches the details when writing a series of articles, there seem to be several small things that always get by and which the ever-watchful fans note immediately and write in about. Many letters have come in regarding the simplest possible super-heterodyne, and in some of these, Radio Digest readers have brought up points that the writer missed. S. L. T. of Allentown, Pa., writes as follows:

"In the super-heterodyne, which you are describing in Radio Digest, beginning with the issue of November 15, the oscillator coupler contains a rotor which is variable in its relation to the stator. I note in many of the kits now on the market that the oscillator couplers are not variable and I want to know if there is any advantage in the variable feature?"

It is often desirable in super-heterodynes to be able to vary the strength of the oscillations imposed on the grid circuit of the first detector tube by the oscillator tube and its accessories. If the energy thus mixed with the incoming signal is too strong it will cause distortion on weak signals from distant stations; if it is too weak, it will cause distortion on the strong signals from locals and unsatisfactory reception will result. If the connections for the oscillator circuit supplied by each manufacturer are followed carefully, fixed coupling will prove perfectly satisfactory. This will necessitate slight changes from the hook-up given for the simplest possible super-heterodyne, but this should not affect the operation. One advantage of variable coupling which was noticed in the simplest possible set was that adjustment of the oscillator coupler made it possible to bring the readings of the two variable condensers almost exactly the same. Adjustment of the oscillator coupler affected the tuning of the oscillator condenser in this way, although variable coupling was not incorporated with that end in view. Fans need have no doubts about using a kit incorporating a fixed coupler as it will work with perfect satisfaction in this set.

### Outside Antenna

J. C. B. of Des Moines, Iowa, wishes to

know if it possible to use this receiver on an outside antenna. Our reply was as follows:

An outside aerial may be used with this super-heterodyne if some means of coupling it to an aerial and ground is provided. This can best be done with a fixed coupler utilizing 6 to 10 turns on the primary and 56 turns on the secondary if on a 3-inch tube, or 80 turns if on a 2-inch tube. The primary should be placed about 1 inch from the secondary so that a loose coupling will result. If the builder does not object to another control, which need be varied only occasionally, a coupler of the usual type may be used with a primary that is variable in its relation to the secondary. This might very well take the form of the low loss unit described by Mr. Fournier in the issue of November 22, omitting the tickler rotor.

Whether a fixed or variable coupler is used it should be placed in another cabinet from the super-heterodyne and preferably should be placed in a cabinet which is lined with thin copper or aluminum. The leads from the primary should go to two binding posts at the rear to the left for connection to antenna and ground, the leads from the secondary should go to two binding posts at the rear to the right for ready connection to the binding posts ordinarily used for the loop. The reason for shielding the coupler cabinet is that the secondary is liable to pick up the signals from stations itself instead of absorbing them from the primary connected to the antenna and ground.

### Long Distance on Loud Speaker

We have a letter from W. B. R. of Baltimore, Maryland, who, while he is very well satisfied with the range of his receiver and lists many stations from the Atlantic and Pacific coasts as being received, complains that he cannot put the Pacific coast stations on the loud speaker and wishes to know if he can add a stage of push-pull amplification to this set.

This can be done, but as in the case of the antenna coupler, we strongly believe that this should be placed in a separate cabinet and shielded. The energy in a push-pull amplifier pulsating at audio

frequencies is quite strong and care must be taken that this energy does not get back into the receiver itself and cause undesirable noises and possibly unwelcome whistles. A small cabinet similar in design to that used in the receiver itself, and made for a panel 7 inches by 10 inches, can readily be obtained and lined with either thin copper or aluminum, which should be grounded. A rheostat is all that need appear on the face of this smaller panel and it will be found that the tube sockets and transformers, and possibly the C battery also, will go into a cabinet of this size. The fan can either place two binding posts at the rear and to the left for connection to the receiver and two more binding posts to the right for connection to the loud speaker, or two jacks can be placed on the panel, one to the left and one to the right.

A short length of double conductor can now be attached to two plugs, one of which is to be inserted in the left jack on the push-pull panel. If it is not desirable to use the push-pull, the loud speaker plug can be inserted in the set; if the push-pull is desired the remaining plug on the short length of the double conductor is inserted in the amplifier jack of the receiver and the loud speaker plug is inserted in the output jack near the right end of the push-pull panel.

### Grid Leaks and Vernier Control

L. S. H. of San Antonio, Texas, who has evidently been using the UV-200 or C-300 detector tube in regenerative circuits, wants to know if variable grid leaks would be of any advantage in this set. This was tried when the set was laid out on a test board before assembly behind the panel and no advantage was found in the use of smoothly variable grid leaks. The UV-201A and C-301A tubes are not critical in this respect when used as detectors.

P. L. M. of Fond du Lac, Wisconsin, noticed that we did not provide vernier control of the condensers. It was taken for granted that the average builder would either purchase condensers in which vernier adjustment was provided or would use a plain type of condenser with a vernier knob. While the vernier feature

is not particularly necessary on the loop tuning condenser, it is very essential for the oscillator condenser as without it even with the slowest rotation of the dial stations can be passed that, with vernier adjustments, can be brought up to full loud speaker volume.

If low loss condensers are used and the oscillator coupler is of good quality, the tuning of the oscillator circuit will be found to be so sharp as to be almost difficult. Even with a vernier dial the plates must be rotated so slowly that the movement can hardly be noted. It is this feature which makes this particular receiver very desirable and enables it to go through the local barrage and bring in the out-of-town stations.

(Radio Digest is preparing a special booklet telling how to build "The Simplest Possible Super-Het," which includes full size panel and baseboard blueprint layouts. This should be ready for distribution by December 10. The cost will be fifty cents.—Editor's Note.)

### Template for a Condenser

After making purchase of a new condenser I found that there was no template with it for marking and drilling the holes in the panels. As I had no desire to guess at the marking of these places I devised a plan for making a template. A piece of paper was cut to about the same size as the condenser end and a hole was made in it for the shaft of the rotor. Using a stamp pad, I inked the surface of the condenser and then the paper was placed on the shaft end and pressed on the inked surface. When the paper was removed I had an accurate template for marking the panel.—Donald I. Witsoman, Liverpool, N. Y.

### Restoring the Tube

If your UV-199 or 201A tube has been overloaded and does not work as well as before it may be restored to its original condition by burning the filament for about an hour with the B battery disconnected.

Hansen "BIRD-CAGE" Radios



**NIGHTINGALE RADIO**

4 Tube Radio Set \$32.50

Without Accessories

A simplified, loud speaking, long range set at a price within the reach of all.

If you want Radio during the long winter nights the Nightingale will give it to you at very nominal cost, and you will be surprised at the remarkable distance and volume you will receive.

Hansen BLUE BIRD. 4 Tube Radio Frequency..... \$57.50

This is a tuned Radio frequency set that is easy to tune and pleases everybody who owns one. You cannot go wrong when you buy it.

AMERICAN CREST. This we believe to be the best high grade 8-tube loop set on the market today..... \$150.00

There are only a few good loop long distance sets on the market and this is one of them. It is our pet and we are proud of it.

Write for New Catalogue

Dealers and Jobbers—Our line is interesting and profitable.

**RADIO DEPARTMENT HANSEN STORAGE CO.**

THE MILLION DOLLAR WAREHOUSE CO.

120-134 JEFFERSON ST. MILWAUKEE

**KENNEDY**

**RADIODYNE**

**Pathe**

**ULTRADYNE**

**MURDOCK**

**MICHIGAN**

**Howard**

**OSARKA**

**MUSIO**

**PFFANSTIEHL**

**PHOENIX**

**ANDREWS**

**MALONE LEMON**

**AUDIOLA**

**GATES**

**GLOBE**

**HARMONY**

**ODELL FERRY**

**PEERLESS**

**DUCKS DELUXE**

**SAAL**

Follow their lead

use

**THORDARSON**

**Super TRANSFORMERS**

Experience has convinced the leading set builders that Thordarson's are the best. Made and UNCONDITIONALLY GUARANTEED by the world's oldest and largest exclusive transformer manufacturer. Follow the lead of the leaders—built or replace with Thordarson's. Audio frequency, 2-1, \$5. 3 1/2-1, \$4. 6-1, \$4.50. Power Amplifying, pair, \$13. Interstage Power Amplifying Transformer, \$8. All dealers. Write for latest bulletins. Thordarson Electric Mfg. Co., Chicago.

Reg. U.S. Pat. Office

**Lincoln**

**RADIO PRODUCTS**

Laboratory

Tested and Approved



**Lincoln Low-Loss Condenser**

Lincoln Low-Loss Grounded Rotor Condenser, 23-plate model is most efficient electrically, strongest mechanically. Several radical improvements. List price \$4.50.

**Lincoln Oscilloscope**

The "superhet" depends for efficiency on its oscillating circuit. The Lincoln Oscilloscope permits such delicate control of oscillations that it produces amazing results. List price \$6.50.

**Lincoln "Long 45" Tuner**

Condenser, inductance and tickler coil all in one. Add a socket, rheostat grid-condenser and leak . . . and you have a wonderfully efficient complete set. Coast-to-coast range with clearness of reception equal to big expensive sets. List price \$10.00.

**Lincoln Collapsible Loops**

Correctly designed mechanically and electrically. Insures quality reception . . . and is most convenient. List price \$6.50. The Lincoln Collapsible Four-Point Tapped Loop is ideal for "superhet" and other radio-frequency circuits. List price \$8.00.

**The Lincoln Kit**

Includes the "Long 45" Tuner. Everything for a 1-tube set with coast-to-coast range. Easy to assemble, easy to add to. List price \$21.50.

**Write for Catalog**

All Lincoln products fully guaranteed. If your dealer cannot supply you, order direct giving his name. Write for illustrated catalog giving full descriptions.

**Lincoln Radio Corporation**

224 N. Wells St. Chicago, Ill.

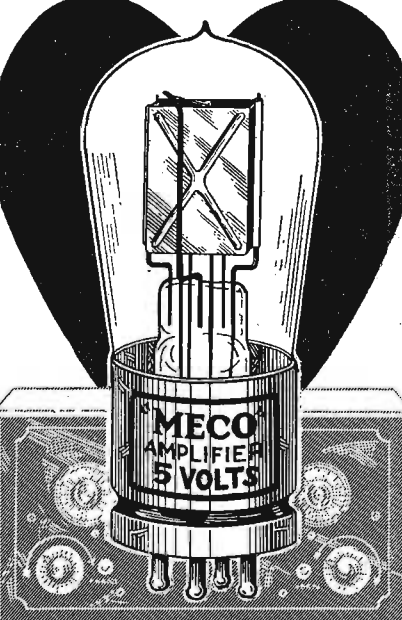

**MECO**

**AMPLIFIER**

**5 VOLTS**

When Its Heart Fails Your Radio is Dead

Since the tubes are the heart of your radio, you are rewarded, for your care in making sure that the tubes you buy have "MECO" stamped on them, by greater volume without sacrificing its clear, distinct receptive tones.

A radical improvement in the construction of MECO Tubes gives them longer life and make them equally effective in every set, whether audio-frequency, radio-frequency, regenerative or reflex action.

MECO Tubes come in 5-volt and 3-volt sizes in large or small bases. Your dealer has MECO Tubes or can get them for you from recognized radio jobbers.

**Metropolitan Electric Co.**

Des Moines, Iowa

**MECO**

**RADIO TUBES**

### LOW LOSS—WHAT IS IT?

(Continued from page 15)

one piece of metal; thus there can be no question of the contact to every plate, as soldering to the lug provided on the real plate automatically connects on to every stator plate without resistance of any kind. A positive contact to the rotor plates and consequent low ohmic resistance is provided by a pigtail connecting the end plate to the rotor shaft. Another unusual feature of this condenser is the vernier adjustment provided. This includes no gears, which precludes the possibility of backlash and lost motion.

The ratio between the vernier knob and the movement of the plates is nine to one. There can be but little high frequency resistance in this condenser as the stator is attached to the rotor by means of four small bakelite spacers and as these are of ample length little leakage can occur. This condenser has positive stops at the ends of the adjustment and is very rigid and strong in its assembly.

#### G. I. Uses Quartz

Another excellent condenser, and one of the first to be brought out on the low loss principal, is that shown in Figure 5.

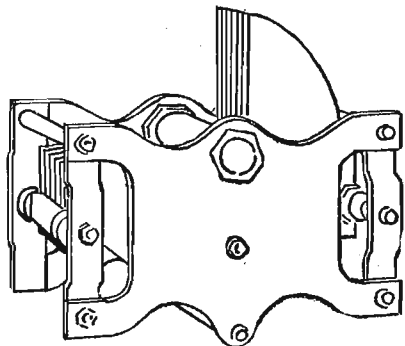
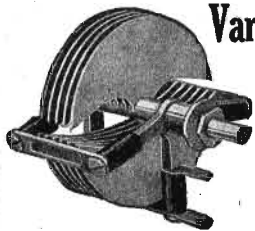

Figure 5.

This condenser is known as the Noloss and is made by the General Instrument corporation. This concern has specialized in the use of extra good dielectric materials and uses as dielectric air, isolantite, pyrex, corantum and quartz. Unfortunately, it is impossible to show in our drawing the use of all these materials, but at every point where dielectric is necessary one of these dielectrics is used. It will be noted that the stator plates are secured to the side members in such a way that a positive contact is certain and its side members are in turn secured to the end plates by means of pyrex. A cup is provided at each end of the metal side supports and other cups are incorporated on the end plates. Between these cups a tube of pyrex glass is firmly clamped and a rigid assembly results. No pigtail is used but a positive contact between rotor plates and the end plates is provided by triple wiping contacts at the front end of the rotor shaft. Ball bearings provide an exceptionally easy turning rotor which makes possible very smooth adjustment of the position of the rotor plates. This condenser is made in a wide variety of maximum capacities and fans are reporting exceptional results through its use.

### Premier "CROFOOT" Vario Condenser



"Look for the condenser with the Red Stripe"

#### 1 to 74 Tuning Ratio

So great a ratio in a standard variable condenser is no accident. It is the result of careful engineering, radically different design and painstaking manufacture.

These facts are convincing evidence of superiority. "CROFOOT" has the lowest minimum capacity yet attained, therefore the greatest tuning ratio and widest tuning range. Extremely low phase angle loss, low insulation leakage and low skin resistance. Made entirely from brass and hard rubber, semi-straight line construction. All plates soldered. Grounded rotor. Lacquered rotor and stator plates. One hole mounting.

Min. Capacity	Max. Capacity	Tuning Ratio	List Price
.000005 M.F.	.0001 M.F.	1 to 19	\$2.75
.000008 M.F.	.00025 M.F.	1 to 42	3.25
.000007 M.F.	.00035 M.F.	1 to 53	3.50
.000007 M.F.	.0005 M.F.	1 to 74	3.75

COMPLETE WITH "E-Z-TUNO" VERNIER DIAL 75 CENTS ADDITIONAL.

Write for Free Bulletin No. 94, showing complete line of Premier Quality Radio Parts. Ask your dealer if he has Premier free hook ups. If not, send his name and receive a set free.

Premier Electric Company  
3810 Ravenswood Ave., Chicago

MAKER OF

# Premier

Quality Radio Parts

### Experimenters, Attention!

HAVEN'T you often wondered just how you could demonstrate to your own satisfaction what the underlying principles of Radio are, and set up the experimental apparatus so as to do this? Beginning next issue, Prof. J. E. Owen, chief of the bureau of standards at the University of Oklahoma, will tell you how to do this very thing, using the limited apparatus you have at hand.

Professor Owen's purpose in his short series of articles will be to present to you in definite and under-

standable language and by means of clear and accurate illustrations, the actual theory underlying the general field of Radio. He will give you actual experimental sets and problems for solution, together with diagrams.

Not all will be simple, nor will all be complex. There will be food for thought for both advanced and beginning Radiophans. The equipment needed will not be more than that already possessed by the average home set builder. You will like this series. Start reading it in next issue, reactions and advice.

At this time there seems to be a need for but four sizes of variable condensers, these being .00025 for short wave receivers, .00035 for neutrodynes and tuned Radio frequency sets, .0005 for both tuned Radio frequency and super-heterodynes and .001 for use in the oscillator circuits of certain super-heterodynes. This has materially helped the manufacturers of condensers as they do not have to put their energy and manufacturing facilities into the construction of so many types and can concentrate on the perfection of but four models. Use of dielectric end plates should not necessarily condemn a condenser with anyone, as the actual difference in efficiency between a condenser of this type and one with metal end plates is not very great. Poor ohmic resistance has been the chief fault of condensers for some time, not the high frequency resistance, and all of the manufacturers seem to be providing a better means of securing plates and better bearings, which reduces the DC or ohmic resistance to a point that cannot be much improved.

(Mr. Fournier will continue his interesting discussion in the next article by considering the Hammarlund, Continental, Gard, Premier and Lincoln condensers. A real low loss set will soon be described. —Editor's note.)

If a local station is too loud on two steps and not loud enough on one step, leave the jack in the second step and control the volume by slightly turning out the signal.

When using a soft tube be sure and have a vernier rheostat.

### An Efficient Portable Counterpoise

During winter and summer months DX reception will be greatly aided by the use of a counterpoise. It is often inconvenient to construct a counterpoise along the ground below the aerial. A portable counterpoise which added one hundred and fifty miles to the range of my set may be built of 250 feet of number 22 bare or

enameled wire and an ordinary wooden barrel hoop. Procure a straight round bar about 1/4 inch in diameter and about 6 inches long. Around this bar start to wind the wire in the same manner as you would a coil but slipping the wound wire off the end to make room for more windings, as you proceed. Wind 200 feet of the wire and slip off the bar.

Now wind the coiled wire around the hoop in two turns and secure in place with staples leaving the fifty feet of unwound wire free as a lead-in. Four tacks should be placed in the rim of the hoop and the loose lead-in attached to each one in turn and brought to a point 3 feet above each time until the counterpoise assumes the form of a cone with the hoop as a base. When in use, it may be lowered, from a window or other convenient place, to 1 foot or more from the ground. If properly constructed it will hang easily and on a level above the ground. The counterpoise may be hoisted during the daytime and be out of the way. The lead-in should be attached to the set at the ground binding post or through a coil. The best method for your particular type of receiver may be determined by experimentation. It will give good results on any make of set.—J. K. Donovan, East Falls Church, Virginia.

## DIETZEN Adjustable LOUD SPEAKER

At the Price of an Ordinary Pair of Head Phones

DEALERS: write for details

SEND NO MONEY!

ORDER BY MAIL

If your dealer cannot supply you we will ship you a complete DIETZEN JR-65 speaker ready for use. Written money back guarantee with each loud speaker.

COMPLETE with specially built DIETZEN adjustable loud speaker unit and plug.



TYPE JR-65

\$6

PLUS A FEW CENTS POSTAGE

NOT a Head Set Unit

### SPECIAL FEATURES

Absolute non-metallic sound. Permanent Crystallized finish.

No batteries necessary. Specially constructed adjustable unit with gold plated diaphragm.

Unconditionally guaranteed for one year from date of purchase against mechanical defects of any kind.

SPECIFICATIONS: Diameter of Horn - 9 INCHES Height 17 INCHES



DIETZEN INC. 71 Cortlandt St. Dept. D. New York

MAKERS OF PRECISION INSTRUMENTS SINCE 1889

FREE! DIETZEN RADIO LOG BOOK WRITE FOR YOURS!

## The "Goode" Two-o-One

# A

Le Ton d'argent

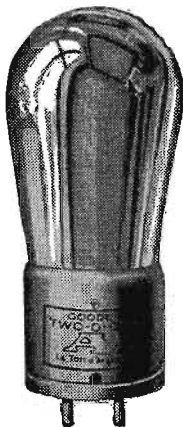

Guaranteed

BY MAIL ONLY

\$2.39

Postpaid

QUARTER AMPERE AMPLIFIER-DETECTOR

## RADIO TUBE

GUARANTEED SATISFACTORY

All "GOODE" Tubes Sold Direct to the Consumer—No Dealer Profits

ONE—"Goode" Detector-Amplifier..... \$2.39  
THREE—"Goode" Detector-Amplifiers..... 6.42  
(All postage prepaid)

The "Goode" Two-o-One A Tube amplifies or detects. It is a quarter ampere, five volts, standard base silvered tube. Send express or postal money order or New York draft to—

The Goode Tube Corporation  
Incorporated  
Owensboro (Dept. A) Kentucky

Write today for your free copy of

## Ward's New Radio Catalogue



Tested and guaranteed Radio Equipment sold without the usual Radio Profits

WARD'S Radio Department is headed by experts who know and test everything new. Who know by experience what is best—what gives the best service.

Our catalogue is prepared under their supervision. It shows all the best hook-ups, everything in parts and complete sets—so simple that you yourself can install them in a short time.

#### Headquarters for Radio

Today Ward's is serving thousands upon thousands of Radio fans who have written for our catalogue, who have been surprised to see how low in price the standard Radio equipment can be sold without the usual "Radio Profits."

You, too, can profit by writing for a free copy of Ward's Radio Catalogue. If interested at all in Radio, you should write for this book. See for yourself the savings.

#### Our 52-Year Old Policy

For 52 years we have sold quality merchandise. We never sacrifice quality to make a low price. In buying Radio Equipment at Ward's, you are buying from a house of proven dependability. Address our house nearest you: Dept. 41-R

# Montgomery Ward & Co.

ESTABLISHED 1872  
The Oldest Mail Order House is Today the Most Progressive

Chicago Kansas City St. Paul Portland, Ore. Oakland, Calif. Ft. Worth



# Helpful Hints to Get the Most from Radio

## Chapter XII—Telephones and Loud Speakers

By Thomas W. Benson

**T**HE telephone or loud speaker bears the responsibility of converting into sound waves the electrical impulses that have been so carefully amplified. Many of the long distance records are due solely to a sensitive pair of telephone receivers, while much of the distortion in some sets is due to poorly designed or indifferently constructed loud speakers. There is quite a difference in the purposes of the two instruments; a telephone headset is not intended for loud speaker duty nor is a loud speaker suitable for the reproduction of weak signals. In order to meet both conditions the device must be adjustable, a feature found on many of the speakers at present.

### Head Sets

A Radio telephone headset represents a high degree of engineering design and no receiver will stand up if abused or mistreated. The steel in the permanent magnets; the size, material and placing of the pole pieces; the material, thickness and diameter of the diaphragm; are all factors that enter into the design and determine the efficiency of the receivers. These factors are quite beyond the control of the user who can only make a selection and care for the device properly.

In purchasing the receivers always insist upon a comparative test with other makes. It pays to wait and test several different makes and if possible compare them on a crystal set. The reason for this is that the signals are always fairly weak on crystal receivers and one is reasonably sure that there is no distortion in the set itself.

The foregoing test determines their sensitiveness to weak current, but the resistance and impedance of the receiver enters into consideration when they are used with vacuum tubes. The phones are rated in direct current resistance, which is at best an arbitrary rating, the impedance or resistance to currents at audio frequencies should be equal to or greater than that of the plate to filament impedance of the tube. A 2,000 ohm phone has close to 22,000 ohms impedance at the average voice frequency, but this value will vary with the insulation used on the wire and the method of winding the phone, and to be sure of having sufficient impedance a 3,000-ohm phone set is to be preferred. The disadvantage of using phones of a higher resistance is the fact they reduce the voltage applied to the plate of the tube and thus reduce the amplification. With lower impedance the amplifiers have a tendency to distort be-

cause the plate current characteristic becomes non-linear.

The other features to look for in a receiver are matters of mechanical design. The case should preferably be of metal to protect the mechanism of the phone, while the head band should permit of ready adjustment and hold the phones snugly to the ears without excessive pressure.

### Care of Telephones

After purchase, the head set should be properly cared for if good service is expected of it. Do not throw the receivers in a drawer or box with other apparatus for the diaphragms are liable to be dented. Any shock, either from a blow or from dropping tends to weaken the magnetism in the permanent magnets, while the same is true of connecting the receivers reversed to the set. The marked cord on a headset goes to the positive terminal of the B battery while the unmarked cord goes to the plate of the last tube. Occasionally the cords are reversed when the set is purchased. To test for this it is well to reverse the connections to the Radio set while a station is tuned in and leave the headset connected the way the signals are loudest. When improperly connected the plate current acts to oppose the magnetism in the permanent magnets and thus weaken them. A test for weak magnets can be made by unscrewing the receiver cap and sliding off the diaphragm. Hold the receivers with the pole pieces down and see if the magnets will support the diaphragm on edge. If the diaphragm drops off the magnets are weak due to one of the causes mentioned and may be brought back by connecting to the set properly, when they will gradually regain their original strength.

A telephone headset is intended to respond to weak signals, and when used as a talker unit, will rattle and clatter because the diaphragm strikes the pole pieces. When used for this duty the diaphragm must be spaced further away from the pole pieces by placing rings of paper between the diaphragm and edge of the receiver shell. This prevents the clatter, but makes the receiver less sensitive to weak signals.

### Loud Speakers

In a loud speaker the problem is to produce the greatest volume of sound with a given input without distortion. To accomplish this many styles of reproducing units have been developed and

numerous shapes and styles of horns. The problem really resolves itself into two parts, first to get the largest movement of a diaphragm with a given current input into the reproducer and then to obtain the movement of the greatest body of air at the mouth of the device with a given movement of the diaphragm. Here again it is really a question of suiting the device to individual needs.

Some types of loud speakers give good volume on moderate strength signals and choke up on loud signals, while others work efficiently when delivering a large volume of sound. Then again we find a speaker that seems to throw the sound in a beam with little dispersion from the mouth of the horn, and others have good dispersion but poor reaching power. We have assumed in the above that the speakers have non-resonant horns when, as a matter of fact, the material of which the horn is made has a pronounced effect upon the reproduction.

Other speakers have no horn, but depend upon a large diaphragm to move the air directly without the use of a horn. Theoretically this would appear to be the ideal form of talker, for a horn is basically wrong, but then the idea of expecting a flat metal diaphragm to reproduce all the tones within the audible range, and many of them simultaneously, is also wrong. Hence, the loud speaker is at best a compromise, and we must make the best of the existing devices. The loud speaker recently announced, in which a metallic plate is mounted within the magnetic field of a coil in the output circuit of the set, which is actually set into vibration, rather than moved like a diaphragm, gives good promise and is a step in the right direction.

The best way to select a loud speaker is to compare several of them in the room in which they are to be used. Where the room is small a speaker with good dispersion is the best, while in a large room the talker must have more of a throw. The latter action is rather hard to express

in words, but the sound is projected in more of a beam from the device. These considerations are in addition to the quality of the reproduction. When one is located in a fairly large town it is not a difficult matter to induce the local dealer to send up several speakers for a comparative test when a little time can be taken in making a selection to suit individual conditions. In isolated places it is necessary to obtain a talker with an adjusting feature on it.

Many persons have tried to use a phonograph as a loud speaker horn with indifferent results. Again, others have had excellent results. Although the phonograph represents extensive research in acoustics it is not always suitable for use with a loud speaker unit, because the throat of the horn is not of the proper size. If the throat is too large for the unit used, and the input power, then the sound is muffled and has no reaching power. This is the most common cause of this trouble. In the author's opinion, the most satisfactory method of adapting the phonograph for Radio work is to use a reproducing unit that vibrates the needle of the phonograph directly, thus retaining the relation between diaphragm and throat size that the designer intended.

(The concluding number in Mr. Benson's series is on tuning. Naturally, this comes last in the discussion of a set and it is the most important. Read it and learn how to operate your set.—Editor's note.)

### Save the Old Parts

A Radio amateur who builds and tears down receiving sets should have a drawer reserved in his home laboratory for saving different parts. Cardboard or small wooden boxes can be used as containers for screws, binding posts, nuts and other odds and ends. Then when there is occasion to use them again these parts will be within easy reach.

### It Brings 'Em In!



### APEX VERNIER DIAL

Do not bother with geared condensers, requiring many holes in the panel and careful lineup of piston shafts, when this marvelous instrument provides the fine adjustment for tuning in distant stations. Radio 10 to 1—quickly applied to any shaft. For sale by all good radio dealers. If unable to obtain, fill in coupon and enclose \$2.50 for nickel finish or \$3.50 for Gold Plated finish.

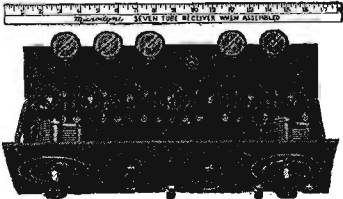

**Coast To Coast On An 18-Inch Loop**  
Assemble Your Own 7 Tube Super-Heterodyne—on a 7 x 18 panel in three hours. \$97.50 buys the parts complete, including drilled and engraved panels, condensers, sockets, transformers, dials, connecting plugs, cables, etc., with drawings, diagrams and instructions. Price of cabinets to fit—furnished on application. If your dealer cannot supply these parts for this complete Microdyne Radio Set, fill in coupon, mail check or money order and send dealer's name.

Apex Electric Mfg. Co., Dept. 1205,  
1410 W. 59th Street, Chicago, Illinois.  
Gentlemen: Enclosed find \$..... for which send me  
Name .....  
Street .....  
City ..... State .....

### Effarsee Brings the Stations In!

Mr. G. B. Pride of Kendallville, Ind., who is using an Effarsee Portable Antennae under the rug of his bedroom with a standard five-tube circuit, writes as follows:

"I am having success with the Type 'B' Effarsee Antennae. It brings in the programs as loud as any one would want them, on the loud speaker, used with my five-tube neotrodyne set, and it reduces the static much more than I thought it would. And, it brings in the DX stations. I have heard the following stations on the loud speaker, while using the Effarsee under the rug in the bedroom. Austin, Texas—1050 miles; Atlanta, Ga.—525 miles; Boston, Mass.—760 miles; Des Moines, Ia.—425 miles; Hastings, Neb.—705 miles; New York City—620 miles; Providence, R. I.—735 miles; Los Angeles, Cal.—1790 miles, and many others."

Mr. Pride, uses type "B", priced at \$1.50. Other sizes \$1.00 and \$2.50.

Effarsee works well with Crystal sets.

If your dealer doesn't carry Effarsee, write us direct. Money back if not satisfied.

FISHWICK RADIO COMPANY  
Edwards Building Cincinnati, Ohio

# Effarsee

PORTABLE ANTENNAE

## A \$200,000.00 COMPANY STANDS SQUARELY BACK OF EVERY PHONE

WEIGHS ONLY 8 OZ

# \$2.95

Plus a few cents postage

**WORLD'S GREATEST HEADSET VALUE**

1. One of the finest phones on the market regardless of price.
2. The most comfortable—weight only 8 oz.
3. Perfect tone mates.
4. Made of standard double pole construction (no single pole nonsense to save expense.)
5. Made of the best materials money can buy. Powerful magnets, genuine tinsel cords, aluminum cases.
6. Manufactured under ideal working conditions.

**SEND NO MONEY**

Order by mail if your dealer cannot supply you and we will ship immediately. Written 5-day money back Guarantee with each set. Our next year's production schedule of two million phones UNDOUBTEDLY places us as the

**WORLD'S LARGEST HEADSET MAKERS**  
**THE TOWER MFG. CO.**  
98 BROOKLINE AVE. BOSTON MASS.

## Radiotron UV-199

### A Small Tube That's a Big Performer

**Radiotron UV-199**  
for detection or amplification

**\$4.00**

The new UV-199 is proving a mighty popular member of the Radiotron family, particularly for portable sets.

For quiet operation—great ruggedness—uniform operation Radiotron UV-199 is unsurpassed. Each new Radiotron has marked a big step in radio advancement. The RCA mark is the foundation of radio growth—and your protection when you buy. Ask for Radiotrons—and look for the mark.

**Radio Corporation of America**  
Sales Offices—Dept. 316  
233 Broadway, New York  
10 South LaSalle St., Chicago, Ill.      433 California St., San Francisco, Cal.

# Radiotron

REG. U. S. PAT. OFF.

### The Reader's View

#### A Reinartz Booster

In the September 27 issue of Radio Digest there are several letters of dissatisfied fans with their present sets. For their benefit and others likewise afflicted let me say—perfect your present set. If you have a sound basic hook-up, don't be stampeded by claims of others. I was that way myself. Up until a year ago I tried everything that came along. I have several shelves piled up with all kinds of junk used in new hook-ups. On an average I made up three or four new ones every day—1,000-mile circuits, super this and super that, single circuits, double circuits, reflex and what not.

In the meantime I had made up four or five old standby Reinartz circuits for others and had wonderful reports of what they done with them. Personally, I had never used one except in the making up process. I concluded to make one for myself and find out what was in it. As soon as I did I stopped experimenting in so far as new hook-ups were concerned. Instead, I started perfecting—am still at it. But I have a set that is a set. When a fellow starts to rave "what he had last night," I ask how many tubes. He will say four, six or eight, as the case may be, and I smile. I had that station perhaps a score of times on two tubes. I had three tubes, but for pure tone reasons cut one out.

Some day when I get to it I will hook on some sort of a push-pull arrangement, but for local stuff within 500 miles at night two tubes are enough for a loud speaker and quite often Chicago, 900 miles away, can be heard on it as good as Philadelphia stations, so why monkey with a lot of tubes? And, listen, fans, with all that, the old set is not yet perfect. When I get around to it I have several ideas that I propose to do to it that I expect will make it say "poppa." No,

there is nothing secret about it. The stuff is in the set. All you have to do is get it out. Shorten a lead here, separate a couple of essential wires there, eliminate a loss about as big as a speck of dust there and eventually the old set will talk like a dutch uncle. And now I say, before you discard a perfectly good hook-up for something probably no better and maybe not as good, spend some work and thought on the old set. It may surprise you.

A year or two ago a certain New York paper published a one control hook-up which is marvelous in its results. A friend of mine sent me his hook-up of it together with a glowing report of what it had done. The best he had done on DX was to reach a station in Oklahoma. I tried it and it was good, but it had nothing on the old standby Reinartz yet. I conceived an improvement in the tuning inductance, wound one and sent it to him to try out. Several weeks ago he told me, "I am getting KGO two and three times a week all through August. August, as you fans know, is static season. There is another example of what perfecting can do. I increased his distance from Oklahoma to California in mid-summer. Perfect the old set.—E. S. Moore, Philadelphia, Pa.

#### About Grand Opera

What is the late news regarding the broadcasting of Grand Opera from the Auditorium this season? I hope they do so and that some other station than KYW will do it. Omaha, WQAW, paralyzes the air so that KYW is about obsolete out in these parts, then all the spark sets in the country send out on 500 or more meters and finish it. The opera people think, and probably it does, that it affects the attendance, but after my wife heard a few numbers she left for Chicago to take in grand opera for ten days. They are a gainer in some ways.—F. A. Swezey, M. D., Wakonda, S. Dak.

**Grimes Inverse Duplex**  
Just completed my hook-up of the Grimes Inverse Duplex as outlined in Radio Digest, issue of nearly a year ago. I used the four tube with aerial operation and wish to say that the results exceeded my fondest expectations in volume, purity of tone, DX and ease of control.—E. D. Lundak, Pierce, Nebr.

#### Raised Markings on Dials

If they have not already done so, why don't the Radio manufacturers make and sell Radio tuning dials with raised markings for the blind? Then they could oper-

ate their own set. Most of the ordinary dials are easily removable and the others could be substituted in their stead.

This would certainly be a wonderful blessing for the afflicted.—Chas. H. Kavanagh, Niles, Mich.

### Six Tools in One

\$1.25

A radio socket wrench that fits every round and hexagon radio nut



Sockets ranging from 1/4" to 1/2"

How it works  
Place socket of required size on end of shaft with slots not in line with lugs on shaft.

Buy it from your dealer or direct from us  
THE PERRY-FAY COMPANY Elyria, Ohio  
Screw Machine Products

12 Cells  
24 Volts  
Solid Rubber Case

**HUDSON-ROSS**  
123 W. Madison St. Chicago

REFLEX  
Elyria, Ohio—Harkness  
Dealers—Send for Brochure

**HUDSON-ROSS**  
123 W. Madison St. Chicago

**HUDSON-ROSS**  
Largest exclusive Radio Jobber in Middle West.  
Write for Brochure  
123 W. Madison St. Chicago



### FADA makes it easy to build a 5-tube Neutrodyne

With the new FADA set of knock-down parts and the new FADA book you can build a 5-tube Neutrodyne receiver that will beat anything you ever had. Outfit No. 169-A sells for \$72. It contains everything necessary. The new enlarged FADA book of 76 pages makes every detail of assembling clear. 30 pages of trouble shooting. Large picture wiring diagram. At your dealer's, 75c.

F. A. D. ANDREA, INC.  
1581 Jerome Ave. New York

**FADA Radio**

## RECEPTRAD KIT



### Build the MULTIFLEX

Greiff Double Selector  
4-tube-Loop Operating

With this kit you can easily build a set that will bring in far distant stations even through local broadcasting—With real volume and clear tone.

Price \$29.50

Send postpaid on receipt of purchase price, if your dealer can't supply you. Write for free wiring diagram of complete circuit.

RADIO RECEPTOR CO.  
59 Bank St.  
NEW YORK

### Dealers Need This



200% Profit

The new FAHNESTOCK Display Case  
Will stimulate your sales of Fahnestock Radio Products. 14 of the most popular styles and sizes are included. Shows the purchaser instantly the correct piece for his set. A constant invitation to buy Fahnestock Products. Dealers are offered 200% profit on each case, an unusual offer on standard merchandise.

Price to Dealer.....\$17.50  
West of Mississippi..... 18.50  
Transportation prepaid when money order or check accompanies order.  
Contents Retail for \$51.50

Refills will be supplied at the regular 100 lot prices, shown in catalogue, which comes with case, less discount shown on enclosed sheet. Send check or money order, today.

FAHNESTOCK ELEC. CO.  
LONG ISLAND CITY NEW YORK



12 Cells  
24 Volts  
Solid Rubber Case

**\$3.50 COD SPECIAL**

### INTRODUCTORY PRICE

For a limited time only, and to introduce this new and superior Storage "B" Radio Battery to the Public, we are selling it for \$3.50. Regular Retail Price is \$5.50. You save \$2.00 by ordering NOW. A finer battery cannot be built than the

### World Storage "B" Battery

(12 CELLS—24 VOLTS)

To ten million homes with Radio Sets—and to countless millions of prospective buyers—this WORLD Storage "B" Battery brings a new conception of battery economy and performance. Here is a battery that pays for itself in a few weeks—will last for years and can be recharged at a negligible cost. And you save \$2.00 by ordering now.

Equipped With A Superior Battery Solid Rubber Case  
Has heavy duty 2-1/8 in. x 1 in. x 1-1/4 in. plates and plenty of acid circulation. Extra heavy glass jars allow ready observation of charge and prevent leakage and seepage of current. It holds its charge, while idle, at constant voltage. You will find this battery a boon to long distance reception. It does away with a great many noises so often blamed on static. Mail your order today.

### SEND NO MONEY

Just state number of batteries wanted and we will ship day order is received. EXTRA OFFER: 4 batteries in series (96 volts), \$13.00. Pay Expressman after examining batteries. 5 per cent discount for cash in full with order. Send your order NOW and save \$2.00.

WORLD BATTERY COMPANY  
Makers of the famous World Radio "A" Storage Battery  
1219 S. Wabash Ave., Dept. 76 Chicago, Ill.

**SAVE \$2.00 BY ORDERING NOW!**

## BLUEBIRD Radio Tubes



Distinctly New AND EFFICIENT, satisfying every radio fan's wish in performance and price. Our direct sales plan enables us to sell at this low figure. "Bluebird" assures increased range and undistorted volume.

Type 400—5 Volts, 1 Ampere Detector Tube  
Type 401A—5 Volts, .25 Ampere Amplifier and Detector  
Type 499—3-4 Volts, .06 Ampere Amplifier and Detector  
Type 499A—3-4 Volts, .06 Ampere with Standard Base Amplifier and Detector.  
Type 412—1 1/2 Volts, .25 Ampere Platinum Filament Amplifier and Detector.

All Standard Types... \$2.50

TYPE 402 5 WATT TRANSMITTERS.....\$3.00

EVERY TUBE GUARANTEED to work in Radio Frequency. Especially adapted for Neutrodyne, Reflex and Super-Hetrodyne Sets.

Shipped Parcel Post C. O. D. When Ordering Mention Type

**BLUEBIRD TUBE CO.**  
200 Broadway NEW YORK CITY

## Make BIG MONEY! IN RADIO

### We Need Men—Can You Qualify?

Ozarka representatives make real money because they give real values and deliver a real service. For instance, there is a 4-tube Ozarka Instrument for loud speaker operation, giving wide range of reception at \$39.50. Our men demonstrate Ozarka Instruments and Install.

The Instrument makes the sale easy by its performance. We train you to know radio and our methods, make you worthy to wear the Ozarka button as our accredited representative. Previous experience is not necessary. In fact we prefer to do our own educating. If you have a clean record, are industrious, and have saved up a little cash, here's a real opportunity, if you can qualify for an exclusive territory. We already have 2247 representatives. Territory going fast.

**FREE, LARGE ILLUSTRATED BOOK**

WRITE Today for illustrated book No. 101 that gives the entire Ozarka Plan. Don't fail to give the name of your county.

**OZARKA, Inc.**  
841 Washington Blvd.  
CHICAGO

### 4 Tube Sets As Low \$39.50

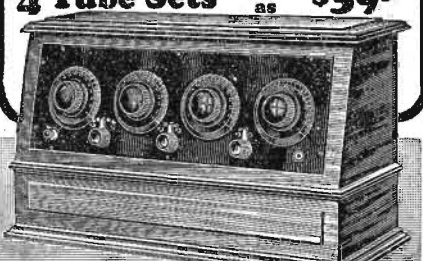

### For Low-Loss Receivers Use the Most Efficient Inductances

*Pfanstiehl*

### VARIOMETER and VARIOCOUPLER



Pat. Pending

Pfanstiehl Variometer, P-301.....	\$4.75
Pfanstiehl Variocoupler, P-300.....	5.00
Pfanstiehl "Three-Circuit" Tuner, P-302.....	5.00
Pfanstiehl Super-heterodyne Oscillator, P-600.....	6.00
Pfanstiehl Coils:	
P-201.....	Turns 25 Price \$ .55 Wave Length 100-340
P-202.....	35 .59 125-470
P-203.....	50 .65 170-650
P-204.....	75 .74 220-960
P-205.....	100 .90 300-1300
P-206.....	150 1.10 470-1980
Pfanstiehl Ultra-Audion, P-225.....	.95
Pfanstiehl Reinartz.....	1.75

**PANSTIEHL RADIO CO.**  
Highland Park, Ill.  
Chicago: 1001 W. Washington St. Haymarket 8010

## FREE To Each Purchaser of a World Battery



A 24-Volt "B" Storage Battery positively given FREE with each purchase of a WORLD "A" Storage Battery. The WORLD Battery is famous for its guaranteed quality and service. Backed by years of Successful Manufacture and Thousands of Satisfied Users. You save 50%.

### Prices That Save and Satisfy

Auto Batteries	Radio Batteries
6-Volt, 11 Plate \$12.25	6-Volt, 120 Amps. 12.50
6-Volt, 13 Plate 14.25	6-Volt, 120 Amps. 14.50
12-Volt, 7 Plate 17.00	6-Volt, 140 Amps. 16.00

Shipment Express C. O. D. subject to examination. 5 per cent discount for cash in full with order.

### 2-Yr. Guarantee Bond in Writing With Each World Storage Battery

proves satisfactory World performance. Mail this ad with your name and address—we will ship battery day order is received; and give you your choice of "B" Storage Battery or a handsome nickel finish Auto Spillite, FREE. Write TODAY.

**WORLD BATTERY COMPANY**  
60 E. Roosevelt Road Dept. L, CHICAGO, ILL.

This FREE "B" Storage Battery takes the place of dry cell "B" batteries. Can be recharged and will last indefinitely. To be sold retail for \$6.00. It is the only battery of its kind equipped with solid rubber case—and insurance against acid and leakage. Take advantage of this remarkable introductory offer NOW. (To those who prefer it, we will send FREE a handsome nickel finish Auto Spillite, instead of the "B" Battery. Be sure to specify which is wanted.)

**GIVEN FREE**

To introduce this new and superior World "B" Storage Battery to the Public





# Selective Hook-up for Long Distance

## Good Circuit Produced by Experimentation

The illustration shows a hook-up which I came upon accidentally. I was experimenting with different circuits until I came upon this one. It is very selective

### WORKSHOP KINKS EARN A DOLLAR—

THERE are many little kinks worked out at home that would aid your fellow Radio worker if only he knew about them. There are new hook-ups, new ways of making parts and various unique ways of operating sets that are discovered every day. Radio Digest is very much interested in obtaining such material. Send them in with full details, including stamped envelope, so rejected copy may be returned. The work must be entirely original, not copied.

RADIO KINKS DEPARTMENT  
Radio Digest,  
510 North Dearborn St., Chicago

and sensitive, as I can tune out the local stations, WLW and WSAI, at will, and have received such distant points as Omaha, Boston, New York, Chicago, Atlanta, Schenectady, etc. There are two variometers in this circuit, one is a split one and the other is regular. A B battery of 45 volts is used. The rest of the diagram is self-explanatory.—Winston Kock, Cincinnati, Ohio.

### Variometer Used as Coupler

When using a variometer as a coupler with the coil wound with 22 or 24 dec. wire you can use the whole variometer as a tickler feedback or by splitting the stator and rotor and wiring the stator of the variometer in series with the coil on the side of the variometer. The coil acts as a loading coil to reach the high wave lengths.

The variometer is one with a coil wound on a 3 1/2-inch tube fastened to the left side by three small angles. The variometer used in the set is a wood form with pigtails to the rotor. A piece

## TWO VARIOMETERS, ONE SPLIT

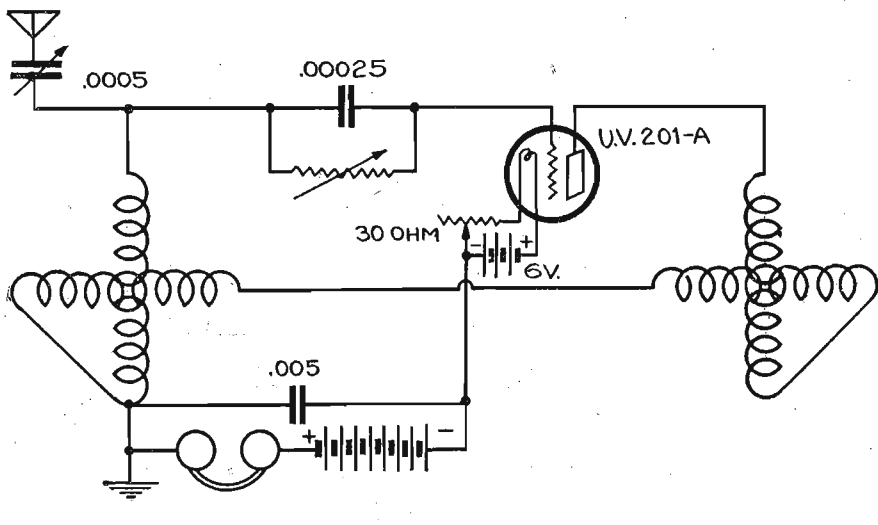

of panel with three binding posts attached makes it easy to change from one circuit to another. One circuit seems to give about the same results as the other

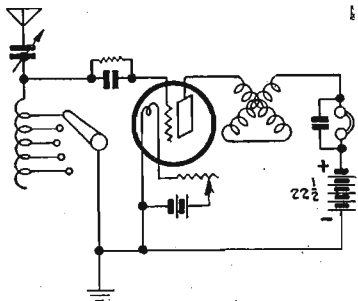

but the grid leak of the first one seems to be more sensitive than the second and for this reason I use the second circuit more than I do the first one. Both circuits are good distance getters, for when using UV-199 tubes either with the detector

or one stage of amplification I have practically received programs from all the

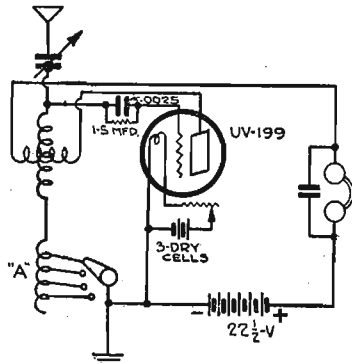

large stations in the United States and Canada.

## Crystal Set Hook-up Uses Split Variometer

By using a split variometer as a tuning unit for a crystal detector I obtained greater distance than I could by using a double slider coil. In the illustration coils 1 and 2 are the rotor and stator of a split variometer. I wound my variometer coils,

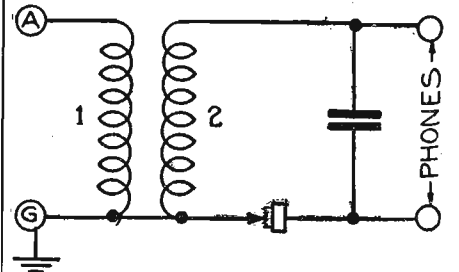

using 25 turns of Number 24 dec. wire on each side of the shaft for the stator and the same number of turns for the rotor. —Claude Williamson, Dallas, Tex.

With the use of the variometer split, without the loading coil and one variable condenser, as in the second circuit the wave lengths cannot be reached, but with the loading coil, fifty turns or more and tapped at every tenth turn, the windings in the same direction as the stator, makes a set that covers considerable range.

The smaller the variable condenser the better, using more turns on the loading coil and less condenser. I would advise the use of about 80 turns on the coil with a 23-plate condenser in the first circuit. With this arrangement about 800 meters can be picked up on the second circuit.—Forest W. Britton, Centerville, Iowa.

Do not use a gas pipe for a ground, as this is strictly against insurance regulations.

**You'll Want This Latest Comprehensive Radio Manual**  
by James R. Cameron, noted authority. Gives beginner or expert exact, practical, usable information on theory, circuits and material. Explanations exceptionally clear.

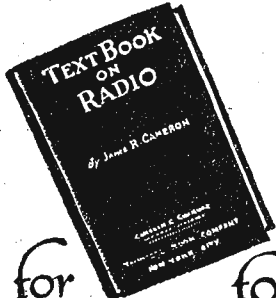

for Beginner - Expert

335 pages fully illustrated. \$1.65 cloth, \$1.95 durable, handsome Flexo-Leather. Send money order or check today.

Money Back if not Satisfied  
C. & C., Inc.

408 Sloan Building, Cleveland, O.

## TRY US! RADIO DEALERS!

We are exclusive Radio Jobbers and DO NOT RETAIL.

Howard—Crosley  
Liberty—Day-Fan  
Receiving Sets

Complete line of parts.  
We Sell to Dealers Only.

Write for Catalog!  
TAY SALES CO.  
6 N. Franklin St., Chicago

## Erla precision parts get the best out of Erla SUPEREFLEX

circuits; most powerful, tube for tube. Ask for Bulletin 24.

Electrical Research Laboratories, Chicago

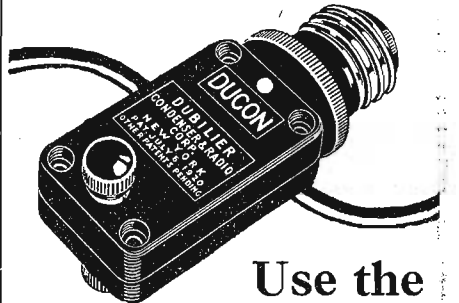

## Use the DUCON

No antenna—just screw the Ducon into your electric light socket and tune in. A great saving in expense and labor—and great results with your set.

PRICE \$1.50

Sold on a 5-day trial basis by all reliable dealers

## Dubilier

CONDENSER AND RADIO CORPORATION

## SHAMROCK FOR SELECTIVE TUNING

Pages 10 and 11

of the Shamrock Booklet tell you how to build the

### Ideal DX

Mail coupon today for the Shamrock booklet telling you how to build this inexpensive set and nine others. Full directions simply told.

SHAMROCK MANUFACTURING CO., Dept. 30-B Market St., Newark, N. J.

I enclose 10 cents (U. S. stamps or coin) for copy of "Shamrock Radio Builder's Guide Book," containing diagrams and complete instructions for building 10 inexpensive sets.

Name.....

Address.....

Dealer's Name.....

## We Want Agents to sell RADIO SETS and Supplies

(Part or Whole Time)

Standard, well advertised merchandise—the kind everybody knows and wants. Make handsome profits representing us. \$5 a day easy in spare time. \$10 to \$20 a day made by many. Buy parts wholesale, sell them at retail. Assemble sets and sell at big profits—or sell our complete sets. Charon of Waukegan, picked off

Big Pay!

\$50.00

A Week Up!

Widener of Kansas City has averaged \$50.00 a week selling radio sets and parts to city and farmer trade. You can do as well—or better. OUTFIT FREE!

\$13 in One Hour

Makes \$75 to \$150 a week regularly. Begin by selling in spare time.

Others do as well and better. Establish yourself in the radio business. No investment required. Write for agency in your locality.

OUTFIT FREE

Address Mail Order Division, Sect. 26

## WAVELAND

Radio Co., Inc., 1027 N. State, Chicago

## MAGNATRON

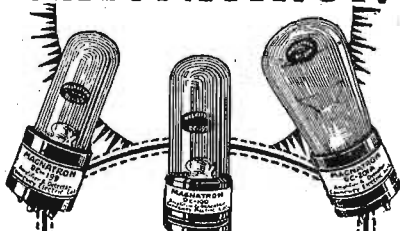

MAGNATRONS today are better tubes than they ever were—they have been changed internally and externally. All types are now manufactured in the tipless form.

All good dealers sell the MAGNATRON DC-201A, and the MAGNATRON DC-199, (both in standard and large base types).

Any Type \$4

CONNELLY ELECTRIC LABS.  
309 Fifth Ave., New York City

## 1st STAR-ITE

### THE STAR-ITE CRYSTAL

Because many people have had good results with the STAR-ITE CRYSTAL sets, we have had a great many letters from radio folks who seem to be of the impression that this is the—as yet unperfected—OSCILLATING CRYSTAL, of which so much has been said in the radio press.

We have secured oscillation with crystals in a laboratory fashion, but would not attempt to sell the STAR-ITE to take the place of amplifying tubes.

We do say that the STAR-ITE is the absolute pinnacle of perfection as a crystal to be used in a REFLEX Set, or a CRYSTAL Set, and as a detector in many non-generative tube sets, and are glad to support our belief by making it extremely easy to try one for yourself.

As this crystal is a new one put out by an old firm in the crystal business your dealer may not have it, but try to get him to order one for you, on our money back guarantee. If he does not wish to do so send us his name with a \$1.00 bill at our risk, and we will send you one with the understanding that you may return it, and we will refund you the \$1.00 at any time within 30 days. Gold Cat Whisker in Each Package

Star Crystal Co.  
1431 525 Woodward Avenue  
DETROIT - MICHIGAN

# Questions and Answers

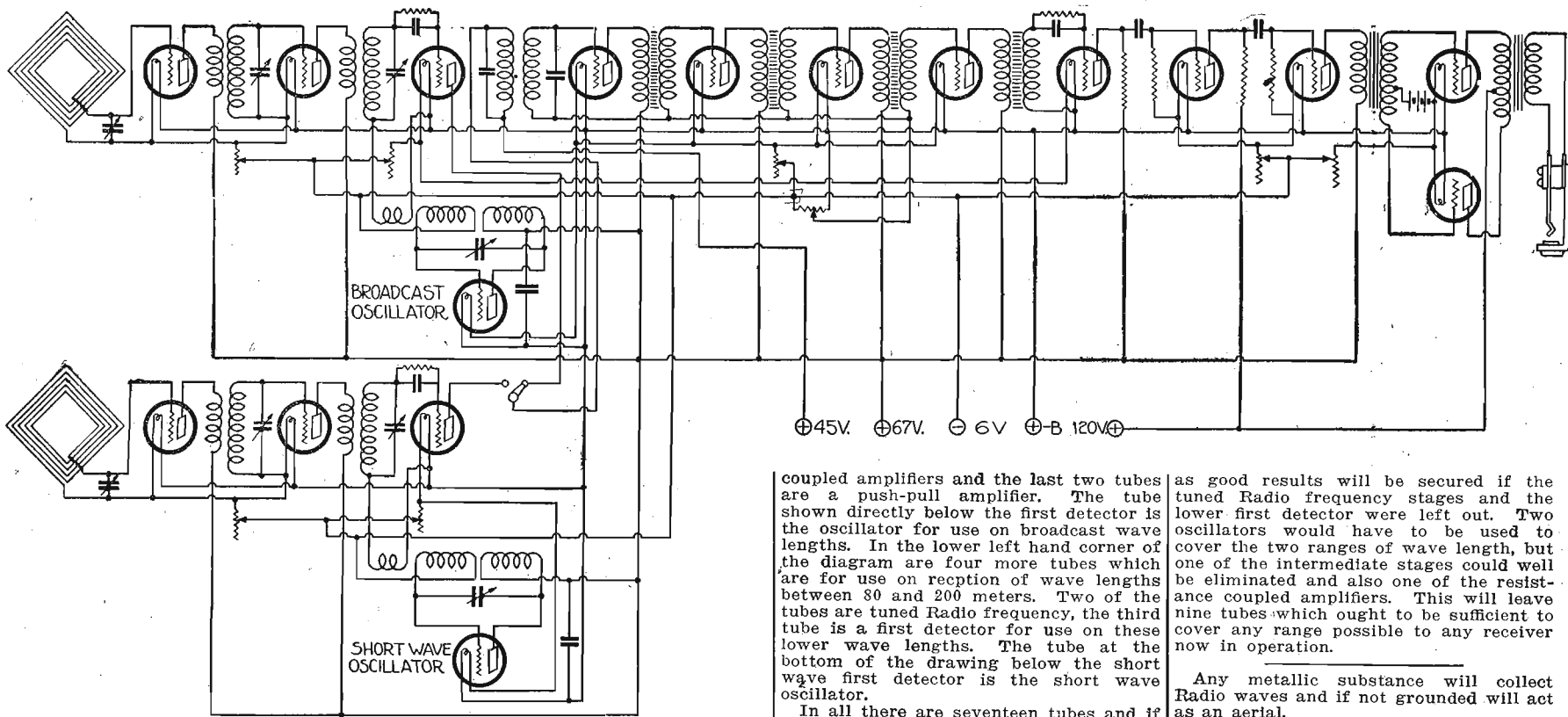

**Sixteen Tube Super-Heterodyne**  
(10893) EWK, Wymore, Nebr.

Please publish a diagram of a sixteen tube super-heterodyne. I have been a reader of Digest, and have built a few sets that have come out in your paper.

A.—We have your letter of October 26th requesting circuit diagram for a super-heterodyne receiver to include sixteen tubes. We are supplying this circuit since it is our policy to supply our readers with anything we can, but we strongly advise against the building of such a set by anyone. In other words, here it is, it is possible, theoretically, but don't do it. The circuit as drawn is perfectly feasible and, if properly made, will undoubtedly work, but we doubt very much

whether its efficiency over a super-heterodyne including only eight tubes is sufficient to warrant the including of the eight extra tubes. Considering the upper row only, the first two tubes are tuned Radio frequency amplifiers, the third tube is a detector or mixer, the following four tubes are intermediate amplifiers at any wave length from 2,000 to 10,000 meters, the next tube is the second detector or rectifier, the next two tubes are resistance

coupled amplifiers and the last two tubes are a push-pull amplifier. The tube shown directly below the first detector is the oscillator for use on broadcast wave lengths. In the lower left hand corner of the diagram are four more tubes which are for use on reception of wave lengths between 80 and 200 meters. Two of the tubes are tuned Radio frequency, the third tube is a first detector for use on these lower wave lengths. The tube at the bottom of the drawing below the short wave first detector is the short wave oscillator.

In all there are seventeen tubes and if you wish to eliminate one of these you can leave out one of the intermediate amplifiers. As stated above, such a set will work, but we feel certain that just

as good results will be secured if the tuned Radio frequency stages and the lower first detector were left out. Two oscillators would have to be used to cover the two ranges of wave length, but one of the intermediate stages could well be eliminated and also one of the resistance coupled amplifiers. This will leave nine tubes which ought to be sufficient to cover any range possible to any receiver now in operation.

Any metallic substance will collect Radio waves and if not grounded will act as an aerial.

**Men to build radio sets in spare time.**  
Leon Lambert, 501-H Kaufman Bldg., Wichita, Kansas.

**S. O. S. S. O. S. S. O. S.**  
A Radio Game, Static, Interference, Fun and Troubles. All the other Christmas presents will be forgotten when you start this game. Get your deck at Dealers or postpaid in Holiday Box \$1.00. Osborn Game Co., Box 702, Kansas City, Missouri.

**158 GENUINE Foreign Stamps.** Mexico War Issues. Venezuela, Salvador and India Service. Guatemala, China, etc., only 5c. Finest approval sheets 50 to 60%. Agents Wanted. Big 72-p. Lists Free. We Buy Stamps. Established 20 years. Hussman Stamp Co., Dept. 153, St. Louis, Mo.

**Send me your burned-out or broken Power tubes—50 watts or over.** Will pay liberally. W. Baker, 36 West 20th Street, New York City.

**PATENT ATTORNEYS**  
PATENTS. Booklet free. Highest references. Best results. WATSON E. COLEMAN, Patent Lawyer, 644 G Street, Washington, D. C.

**For Sure Results, Solder Up Your Set with SOLOX**  
The scientific soldering solution that makes sound metallic joints a certainty, with freedom from acid, messy grease or resin. Easy and clean in use and cannot corrode. Most effective and economical of all preparations. Of your dealer or mailed for 50c by the inventors and manufacturers. The D. X. Radio Research Laboratories, Crugers-on-Hudson, N. Y. Money bank guarantee. Dealers: Write for attractive proposition to our national distributors. THE CHARLES RADIO CO., 154 Nassau St., N. Y. C.

**Your Crystal Set**  
will work 400 to 1,000 miles if made by my plans. No tubes or batteries. Copyrighted plans \$1.00; or furnished FREE with complete parts for building set, including special coil and panel correctly drilled for only \$5.00. Satisfaction guaranteed or money refunded. Satisfied customers everywhere. Particulars free.  
**LEON LAMBERT**  
501 Kaufman Bldg. Wichita, Kansas

**Going Into the Radio Business?**  
You Must Buy Right If You Hope To Make Money  
Send for our new illustrated catalog, with prices and discounts.  
**WHOLESALE ONLY**  
**MANHATTAN RADIO CO.**  
112 Trinity Place New York City

**RADIO CLUB PINS**  
Pins shown designed especially for RADIO CLUBS. Words "Radio Club" cannot be changed. Other lettering can, only name must not exceed 8 letters. Silver plate, 25¢ ea., \$2.50 doz. Sterling silver, 40¢ ea., \$4.00 doz.  
SEND FOR FREE CATALOG  
BASTIAN BROS. CO. 603 Bastian Bldg., Rochester, N. Y.

**LATEST WHOLESALE RADIO CATALOG**  
**FREE** Simply send name TODAY for big 48-page catalog of latest radio goods at Wholesale. Live dealers and agents wanted.  
**STANDARD RADIO CO., 106 East 13th, Kansas City, Mo.**

**CARTER**  
New Portable Jack  
75c  
For Extending Loud Speaker or Phones  
Carter quality throughout. Fits any standard Jack. Properly insulated. Sturdily made. Will not short and cause trouble. Any dealer can supply.  
Write for catalog of other Carter Products. In Canada, Carter Radio Co., Limited, Toronto  
**Carter Radio Co.**  
205 S. STATE STREET CHICAGO

**KEYSTONE APPLIERS**  
The method of bringing your lead in through the Keystone Arrester assures maximum reception. New genuine B-Kolite type, approved by Underwriters, \$1.50 at dealers.  
**Electric Service Supplies Co.**  
Philadelph., Pa.

**RADIO TUBES**  
Our Plant is turning out 10,000 Auto Lamps daily. Now making DETECTOR AND AMPLIFIER TUBES. FEDERATED BY-TONE MODEL 71, Type R. T. 201A, Quarter Ampere, Five Volts, Standard Base. Sold direct by mail to consumer with an ABSOLUTE GUARANTEE. PRICE \$2.30 POSTPAID. 2% for cash or net C. O. D.  
**FEDERATED MOTOR PRODUCTS CORP.**  
250 West 54th Street New York City

**GUARANTEED RADIO TUBE REPAIRS**  
Mail to our nearest office your burned out or broken tube, any type, and we will send you a guaranteed R-S-K repaired Cunningham or Radiotron, any type you wish, C.O.D. \$2.50 each. No extra charge for changing type.  
We sell repaired tubes for \$2.75, if you have no burned out one to turn in.  
We ship Parcel Post, C.O.D., 24-hour service. No waiting.  
Every repair is tested and equal to new. Try yours 30 days. If not delighted, mail it back and we will replace or refund, provided only you have not burned out the filament.  
Dealers: Write for Our Proposition  
**THE R-S-K COMPANY**  
310 Caxton Building, Cleveland, Ohio  
771 Elliffett Square, Buffalo, N. Y.  
609 Ch. of Commerce, Pittsburgh, Pa.

**The House of Coils**  
FOR FOLLOWING CIRCUITS  
Type A AMBASSADOR.....\$4.00  
Type C SUPERDYNE..... 5.75  
Type D NEUTRODYNE..... 6.00  
Set of three  
Type E HARKNESS REFLEX.....\$4.00  
Set of two  
Type F SUPER HETERODYNE  
OSCILLATOR .....\$4.00  
Dealers and Jobbers write for proposition  
If not at your dealers, write direct  
Manufactured by  
**UNIQUE COIL CO.**  
1625 Amsterdam Ave. New York City

**SCIENTIFIC FIXED CRYSTAL DETECTOR**  
BEST BY TEST  
Price, \$1.50  
Manufactured by  
**SCIENTIFIC RESEARCH LABORATORIES**  
502 N. Howard Street Baltimore, Md.  
If your dealer cannot supply you order direct.

**MIRACO RADIO GETS 'EM COAST TO COAST**  
only \$1.45  
FOR THIS GUARANTEED LONG DISTANCE RADIO  
Users everywhere report Miraco Tuned Radio Frequency receivers pick up programs coast to coast; outperform sets three times as costly. Send for proof they are radio's most amazing values in powerful long distance sets. One tube guaranteed, completely assembled outfit, as illustrated, list \$14.35. Three tube guaranteed loud speaker outfit, list \$29.50.  
SEND POSTAL TODAY for latest bulletins and special offer. It will interest you.  
**AGENTS DEALERS**  
The new Miraco proposition is a winner. Write.  
**MIDWEST RADIO CORP'N**  
Builder of Sets  
437-H E. 8th St., Cincinnati, O.

**Send NO Money Hear What YOU Like**  
Stations gladly put on numbers at your request. We print cards that get ATTENTION.  
**SAMPLE CARD FREE**  
Thank your favorite stations and talent. They appreciate applause as musicians on the stage do. Be up-to-date. Got the most out of your radio. Use Postal Thank You Cards.  
**YOUR OWN NAME AND ADDRESS PRINTED FREE**  
on each card. Be individual. Good grade cards. Quality printing. Attention Getting Thank You Cards: 100—only \$1.00; 200—\$1.60; 300—\$2.00; 500—\$3.00; plus postage.  
**Money Refunded if Not DELIGHTED**  
Don't send one cent. Just pay postman after cards arrive. If you prefer to send check or money order with order we prepay postage. You will be more than pleased. Order Today—NOW. A postal will do.  
**RADIO PRINTERS, 49 Main Street, MENDOTA, ILL.**

**U.S. TOOL CONDENSERS**  
TRADE MARK  
**The Innovation of the Year**  
**ONE PIECE STATOR**  
(Pat. Applied for)  
EXCLUSIVE, UNIQUE FEATURE—Recognized by entire radio world. Eliminates broken contacts, soldered joints, leakage, resistance. In types 3 (plain), and 4 (all-vernier), CELORON END PLATES: Types 5 (plain) and 6 (all-vernier), METAL END PLATES.  
CS and CV Low Price Types Always in Stock. Ask Your Dealer!  
**100% Guaranteed**  
**U. S. TOOL COMPANY, INC.**  
122 Mechanic St. Newark, N. J.  
Manufacturers of Special Tools, Dies, Jigs, Automatic Machinery and Sub Presses.

**DEALERS!**  
Write for Discounts on  
FEDERAL ACCURATUNE  
PREMIER BURNS  
FROST SHAMROCK  
DUBILIER REMLER  
BREMER-TULLY  
SHAMROCK-HARKNESS  
REFLEX KITS IN STOCK  
**PRAIRIE STATE RADIO CO.**  
39 West Adams St. Chicago, Ill.

**FREE Catalog!**  
**For DEALERS Only**  
Send name TODAY for our big, new 84-page catalog. FREE to dealers only. Fully illustrated, with descriptions and special prices on high grade standard sets and supplies.  
Unusually attractive discounts to dependable dealers. Orders filled same day received.  
Write NOW for big, free catalog.  
**FEDERAL RADIO COMPANY**  
Distributors of High Grade Radio Sets and Supplies  
314 So. 19th St. OMAHA, NEBRASKA